





FULLY 10-41

Three simple line-art icons of bicycles, representing the Fully category.

HARDTAIL 42-85

Four simple line-art icons of bicycles, representing the Hardtail category.

ROAD 86-117

Five simple line-art icons of bicycles, representing the Road category.

TREKKING 118-145

Seven simple line-art icons of bicycles, representing the Trekking category.

URBAN 146-159

Two simple line-art icons of bicycles, representing the Urban category.

KID 160-179

Four simple line-art icons of bicycles, representing the Kid category.

INFO 180-193

Three icons: a globe, a smartphone, and a bicycle, representing the Info category.

MADE IN AUSTRIA



Seit Jahrzehnten beweist KTM seine Kompetenz als einflussreicher und globaler Fahrradhersteller.

Die Fahrradtechnik hat sich vielfach verändert und enorme Fortschritte gemacht. Im Laufe dieser Zeit hat sich KTM zu einem der letzten verbliebenen Vollsortimenter entwickelt. Eines jedoch ist immer gleich geblieben: KTM baut nach wie vor "Bikes – Made in Austria".

Bereits das erste KTM Fahrrad Fleetwing trug 1964 das Gütesiegel Made in Austria. Mehr als 50 Jahre später ist KTM stolz darauf, seine Fahrräder wieder mit diesem Siegel zu versehen, das für höchste Qualität und modernste Technologien steht. Mittlerweile wird in mehr als 50 Ländern weltweit auf KTM Bikes – Made in Austria vertraut.



KTM has spent decades developing into an influential player in the global bicycle sector.

Bike technologies have changed enormously and the progress has been significant especially in the last decade. As the decades have past KTM finally became a manufacturer that covers the whole range of bikes. But one thing has never changed: KTM still builds bikes at its base in Mattighofen awarding the badge – Made in Austria.

The first KTM bike the Fleetwing, displayed the quality label Made in Austria (1964). More than 50 years later KTM is proud to label the biggest part of its bikes again with that mark standing for highest quality and state-of-the-art technologies. In addition to this, more than 50 countries around the world trust in KTM Bikes – Made in Austria.



1964



1972



1978



1982



1991



1994



2000



2003



2009



2020

TAPERED STEERER

Das konifizierte Steuerrohr erhöht die Steifigkeit und Lenkpräzision

The tapered steerer optimizes the riding feeling and increases the stiffness.

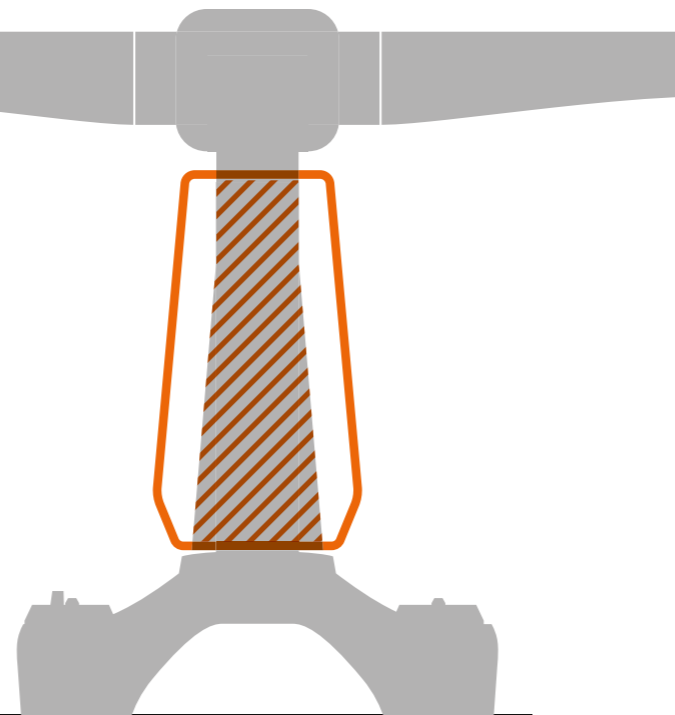

REMOTE FORK LOCKOUT

Die Lockout-Funktion der Federungs-elemente wird mit einem ergonomischen Hebel vom Lenker aus betätigt. Beide Hände bleiben sicher am Lenker.

The lock out function of the suspension elements is actuated with an ergonomic lever on the handlebar. Both hands remain safely on the bar.

REMOTE DAMPER LOCKOUT

Die Dämpfer Lockout Funktion wird mit einem ergonomischen Hebel vom Lenker aus gesteuert. Beide Hände bleiben immer sicher am Lenker.

The fork lockout can be controlled by an ergonomic remote lever and your hands remain on the bar.

REMOTE DROPPER POST

Um die volle Kontrolle bei schwierigen Abfahrten zu behalten, lässt sich mittels Lenkerfernbedienung samt vollintegrierter Zugverlegung die Sattelstütze absenken. Bei KTM nicht nur auf rein abfahrtsorientierten Bikes zu finden.

To maintain full control during difficult descents, the seatpost can be lowered with a handlebar remote control for ease whilst riding. The cable routing is also fully integrated.

BOOST 148mm

Der Boost Standard erhöht die Steifigkeit und ermöglicht ein effizienteres und präziseres Handling des Bikes. Durch die breitere Nabe lassen sich robustere Laufräder bauen.

The Boost Standard increases stiffness and allows a very efficient and precise handling of the bike. The wider hub makes it possible to build more robust wheels.

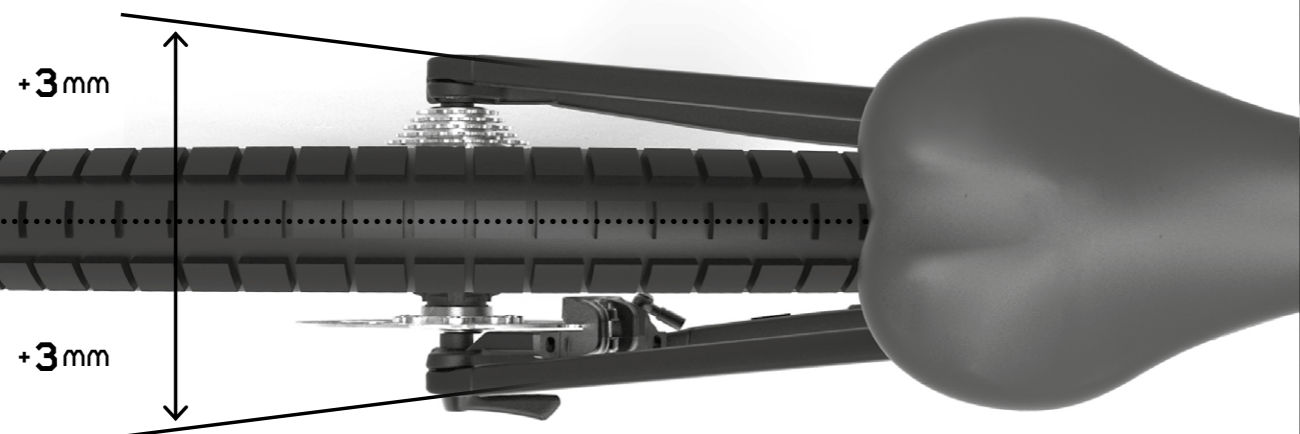

NANO PREMIUM CARBON

Hochmodulare Carbonfasern mit Nanomatrix. *Highly modular carbon fibres with nanomatrix.*

PC PREMIUM CARBON

Hochmodulare Carbonfasern. *Highly modular carbon fibres.*

PERFORMANCE CARBON

Carbonfaser-Mischung zur perfekten Anpassung an die unterschiedlichen Belastungszonen.

A mixture of different carbon fibres for a perfect adaption to the different strain zones.

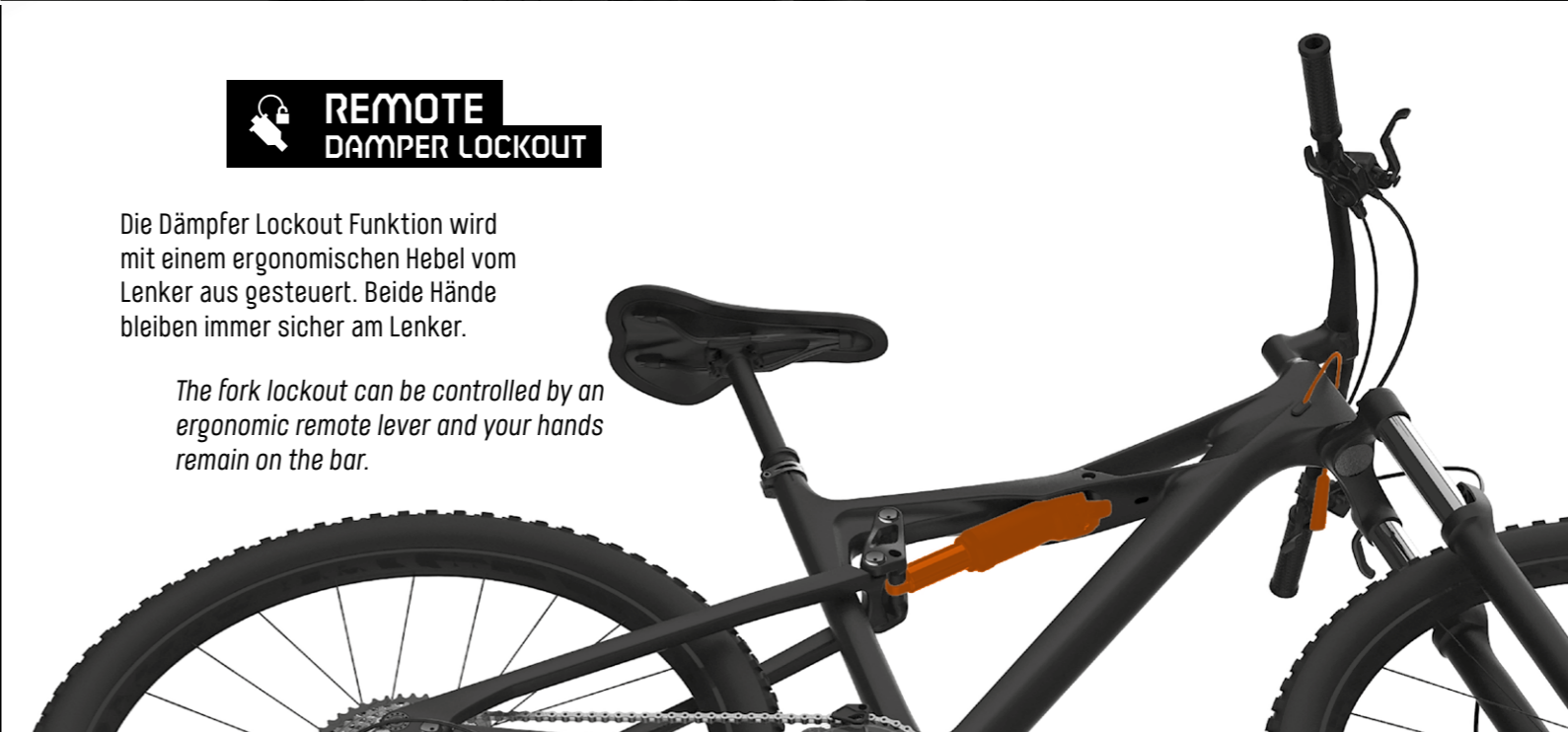



1x12 GEARING

Durch den Wegfall des Kettenwerfers und des zweiten (dritten) Kettenblattes wird das Gewicht reduziert und die Bedienbarkeit vereinfacht. Die modernen 1x12 Antriebssätze bieten mit einer Übersetzungsbandbreite von bis zu 510% eine beinahe ebenbürtige Bandbreite im Vergleich zum 2x11 Antriebsatz.

Without a front derailleur and the use of only one chainring, the weight gets reduced and the operability becomes easier. With a gear ratio spectrum from up to 510%, all modern 1x12 drive trains provide almost the same gear range compared to the 2x11 versions.

12mm THRU AXLE REAR

Einfache und sichere Handhabung bei der Hinterrad (De-)Montage. Der durch das 12 mm KTM Thruaxle System versteifte Hinterbau setzt die Pedalkraft höchst effizient um.

Easy and safe handling with the rear wheel (dis-)mounting. Due to the 12 mm KTM thru axle system, the stiffer rear triangle converts the pedal force to be at its most efficient.



STRAIGHT LINE LINK

Die direkte Krafteinleitung in das Federelement reduziert Belastungen der Lager und des Rahmens. Gepaart mit dem geringen Übersetzungsverhältnis spricht der Hinterbau sehr sensibel an und lässt sich optimal auf das Fahrergewicht abstimmen. SLL ist auch optimiert für größere Federwege (SLL-LT)

The direct force application to the suspension reduces loads on the bearings and the frame. Coupled with the low transmission ratio, the rear end is very supple and can be perfectly adapted to the weight of the rider. SLL is also optimized for longer travel (SLL-LT)

FORK PICTURE BY SRAM



15mm THRU AXLE FRONT

Durch den größeren Achsendurchmesser und die stabile Verbindung der beiden Gabelholme wird eine erhöhte Lenkpräzision und ein verbessertes Ansprechverhalten der Gabel erreicht.

The larger diameter axle and the improved fork legs contact result in a higher stiffness as well as improved steering precision and characteristics.

iM INTEGRATED POSTMOUNT

Die Aufnahme des Bremssattels fügt sich nahtlos in das Rahmendesign ein und spart dadurch zusätzlich Gewicht.

The postmount is seamlessly integrated into the frame design which is additionally saving weight.



iFM INTEGRATED FLATMOUNT

Speziell für den Rennradbereich entwickelte Bremssattelaufnahme. Perfekt in den Rahmen integriert, um höchsten Ansprüchen gerecht zu werden.

To meet the high demands of our riders the Flatmount Disc Mounting is the ideal technology with a slim and elegant design

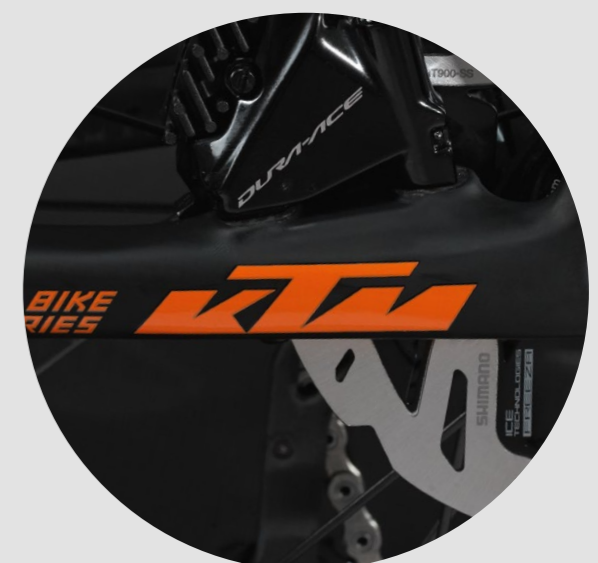



PROWLER



PROWLER SONIC
XTR 1x12 12-15



PROWLER MASTER
DEORE XT 1x12 16



PROWLER GLORY
DEORE XT/SLX 1x12 18



PROWLER 291
DEORE XT/SLX 1x12 19



PROWLER 292
SX 1x12 20

SCARP MT



SCARP MT PRESTIGE
XX1 AXS 1x12 22-24



SCARP MT PRIME
XTR 1x12 26



SCARP MT MASTER
DEORE XT 1x12 27



SCARP MT GLORY
DEORE XT/SLX 1x12 30-31



SCARP MT ELITE
SLX 1x12 32

SCARP



SCARP SONIC
XTR 1x12 34-37



SCARP PRIME
XTR 1x12 38



SCARP MASTER
DEORE XT/SLX 1x12 39



SCARP ELITE
SLX 1x12 40



SCARP 294
SX 1x12 41

PROWLER

SONIC



Das 150 mm Adventure Fully für den Kolumbus der Alpen.

Die Zeit der großen Entdecker scheint lange vorüber, doch das PROWLER bringt ein Stück dieser Sehnsucht zurück. Mit diesem Fully steht deiner ganz persönlichen Expedition in die Wildnis nichts

mehr im Wege. Ob quer durch Wälder, über Bergketten, hin zum Secret-Spot oder im Bikepark, das PROWLER garantiert ein Trail-Erlebnis der Extraklasse und führt dich weit weg vom Alltäglichen.

Das Straight-Line-Link (SLL) Rahmen-Dämpfungskonzept steht nach wie vor für perfektes Ansprechverhalten und maximalen 150 mm Federweg-Spaß. Neben den stark ausgeprägten Downhill-Genen überzeugt das Prowler mit seinen Klettereigenschaften, die in diesem Bike-Segment seinesgleichen suchen. Ein niedrig angelegtes Cockpit und 75 Grad Sitzwinkel machen es möglich.

The 150 mm adventure fully for the Columbus of the Alps.

It seems the time of the great adventurers has long gone, but the PROWLER brings back some of this aspiration. With this fully you can immediately start your personal expedition into the wilderness.

Whether across the woods, over mountain ranges, straight to your secret spot, or down the bikepark, the PROWLER guarantees the superb trail experience and brings you far away from everyday life. The

Straight-Line-Link (SLL) frame damping technology still stands for perfect response and maximum 150 mm travel fun. Beside the strong downhill genes the Prowler satisfies you with its, for this bike segment unusual, climbing skills. Possible due to a low designed cockpit and a 75 degrees seat angle.



PROWLER

SONIC

1x12 SHIMANO XTR

150 mm REAR



FRAME Prowler 29" Performance Carbon SLL150mm / M-8606

FORK FOX 36 Float 29" Factory 150mm (Kashima)

SHOCK FOX Float DPX2 Factory 3Position 230x65

R. DERAILL. Shimano XTR M9100-12 SGS shadow+

SHIFTLEV. Shimano XTR M9100-12

CRANKSET Shimano XTR M9120 32T

SPROCKET Shimano XTR M9100-12 / 10-51

CHAIN Shimano XTR M9100-12

DRAKE Shimano XTR M9120 4-Piston

ROTOR Rotor MT900 CL 180 / 180 Freeza

WHEEL F KTM Prime Trail 29 CL 110-15TA 622x30TC TLR made by DT Swiss

WHEEL R KTM Prime Trail 29 CL 148-12TA 622x30TC TLR made by DT Swiss

TIRE F Maxxis Minion DHF 3C-MaxxTerra/EXO/TR 58-622

TIRE R Maxxis Minion DHR II 3C-MaxxTerra/EXO/TR 58-622

GRIP Ergon GE10 Evo ergonomic

BAR KTM Prime Trail35 Carbon rizer20 800mm

STEM KTM Team Trail35

HEADSET KTM Prime drop/in 1.1/8-1.5" +5

SADDLE Ergon SM10 Sport Men

SEATPOST FOX Transfer Factory internal

CATEGORY 4

SYSTEM WEIGHT 120 kg (permissible total weight)

WEIGHT 13.2 kg (without pedals)



space orange (black)

- 020100103 PROWLER SONIC S / 43cm
- 020100108 PROWLER SONIC M / 48cm
- 020100113 PROWLER SONIC L / 53cm

PROWLER MASTER

⚙️ 1×12 SHIMANO
DEORE XT

🔪 150 mm
REAR



FRAME Prowler 29" Performance Carbon
SLL150mm / M-8606

FORK FOX 36 Float 29" Performance 150mm

SHOCK FOX Float DPX2 PerformanceElite
3Position 230x65

R. DERAILL. Shimano Deore XT M8100-12 SGS shadow+

SHIFTLEV. Shimano Deore XT M8100-12

CRANKSET Shimano Deore XT M8120 30T

SPROCKET Shimano Deore XT M8100-12 / 10-51

CHAIN Shimano Deore XT M8100-12

BRAKE Shimano Deore XT M8120 4-Piston

ROTOR Rotor MT800 CL 180 / 180 Freeza

WHEEL F KTM Comp Trail 29 CL 110-15TA
622x30TC TLR made by DT Swiss

WHEEL R KTM Comp Trail 29 CL 148-12TA
622x30TC TLR made by DT Swiss

TIRE F Maxxis Minion DHF 3C-MaxxTerra/EXO/TR 58-622

TIRE R Maxxis Minion DHR II 3C-MaxxTerra/EXO/TR 58-622

GRIP Ergon GE10 Evo ergonomic

BAR KTM Team Trail35 rizer25 800mm

STEM KTM Team Trail35

HEADSET KTM Team drop/in 1.1/8"-1.5" +5

SADDLE Ergon SM10 Sport Men

SEATPOST FOX Transfer Performance internal

CATEGORY ⬠ 4

SYSTEM WEIGHT 120 kg (permissible total weight)

WEIGHT 13,8 kg (without pedals)



■ olive grey matt (black glossy)

- 🔪 020101103 PROWLER MASTER S / 43cm
- 🔪 020101108 PROWLER MASTER M / 48cm
- 🔪 020101113 PROWLER MASTER L / 53cm

THERE'S NOWHERE TO GO BUT EVERYWHERE



PROWLER

GLORY



1x12 SHIMANO DEORE XT/SLX
150 mm REAR

1x12 SHIMANO DEORE XT/SLX
150 mm REAR

PROWLER

291



FRAME Prowler 29" Performance Carbon SLL150mm / M-8606
FORK FOX 36 Float 29" Performance 150mm
SHOCK FOX Float DPX2 PerformanceElite 3Position 230x65
R. DERAILL. Shimano Deore XT M8100-12 SGS shadow+
SHIFTLEV. Shimano Deore XT M8100-12
CRANKSET Shimano Deore XT M8120 28T
SPROCKET Shimano SLX M7100-12 / 10-51

CHAIN Shimano SLX M7100-12
BRAKE Shimano SLX M7120 4-Piston
ROTOR Rotor RT70 CL 203 / 180
WHEEL F KTM Line - Shimano SLX M7110B CL 28H 110-15TA Mavic E-XM430 28H 622x30TSS
WHEEL R KTM Line - Shimano SLX M7110B CL 28H 148-12TA Mavic E-XM430 28H 622x30TSS
TIRE F Maxxis Minion DHF 3C-MaxxTerra/EXO/TR 58-622
TIRE R Maxxis Minion DHR II 3C-MaxxTerra/EXO/TR 58-622

GRIP Ergon GE10 Evo ergonomic
BAR KTM Team Trail35 rizer25 800mm
STEM KTM Team Trail35
HEADSET KTM Team drop/in 1.1/8-1.5" +5
SADDLE Ergon SMA10 Gel Women
SEATPOST KTM Comp dropper internal w/remote
CATEGORY 4
SYSTEM WEIGHT 124 kg (permissible total weight)
WEIGHT 14 kg (without pedals)

FRAME Prowler 29" Alloy6061 triplebutted SLL150mm / M-9616
FORK Marzocchi Bomber Z2 29" 150mm
SHOCK FOX Float DPS Performance 3Position 230x65
R. DERAILL. Shimano Deore XT M8100-12 SGS shadow+
SHIFTLEV. Shimano Deore XT M8100-12
CRANKSET Shimano Deore XT M8120 30T
SPROCKET Shimano SLX M7100-12 / 10-51

CHAIN Shimano SLX M7100-12
BRAKE Shimano SLX M7120 4-Piston
ROTOR Rotor RT70 CL 203 / 180
WHEEL F KTM Line - Shimano SLX M7110B CL 28H 110-15TA Mavic E-XM430 28H 622x30TSS
WHEEL R KTM Line - Shimano SLX M7110B CL 28H 148-12TA Mavic E-XM430 28H 622x30TSS
TIRE F Schwalbe Hans Dampf Perf. TLR 60-622
TIRE R Schwalbe Hans Dampf Perf. TLR 60-622

GRIP Ergon GE10 Evo ergonomic
BAR KTM Team Trail35 rizer25 800mm
STEM KTM Team Trail35
HEADSET KTM Team drop/in 1.1/8-1.5" +5
SADDLE Ergon SM10
SEATPOST KTM Comp dropper internal w/remote
CATEGORY 4
SYSTEM WEIGHT 130 kg (permissible total weight)
WEIGHT 15,5 kg (without pedals)



deeppurple (mandarin)

020102103 PROWLER GLORY S / 43cm
 020401108 PROWLER GLORY M / 48cm



faded grey matt (white glossy)

020103103 PROWLER 291 S / 43cm
 020103108 PROWLER 291 M / 48cm
 020103113 PROWLER 291 L / 53cm

PROWLER

292

⚙️ 1×12 SRAM SX

🔪 150 mm REAR



FRAME Prowler 29" Alloy 6061 triplebutted SLL150mm / M-9616
FORK RockShox 35 gold RL 29" 150mm 15x110
SHOCK RockShox Deluxe Select+ 230x65
R. DERAILL. Sram SX Eagle 12speed
SHIFTLEV. Sram SX Eagle Trigger
CRANKSET Sram SX Eagle DUB 30T
SPROCKET Sram SX Eagle PG1210 / 11-50
CHAIN Sram NX Eagle 12s

BRAKE Shimano MT420 4-Piston
ROTOR Rotor RT64 CL 203 / 180
WHEEL F KTM Line - Shimano Deore M6010B CL 32H 110-15TA
 Mavic E-XM430 32H 622x30TSS
WHEEL R KTM Line - Shimano Deore M6010B CL 32H 148-12TA
 Mavic E-XM430 32H 622x30TSS
TIRE F Schwalbe Hans Dampf Perf. TLR 60-622
TIRE R Schwalbe Hans Dampf Perf. TLR 60-622
GRIP Ergon GE10 Evo ergonomic

BAR KTM Team Trail35 rizer25 800mm
STEM KTM Team Trail35
HEADSET KTM Team drop/in 1.1/8>1.5" +5
SADDLE Ergon SM10
SEATPOST KTM Comp dropper internal w/remote
CATEGORY ⬢ 4
SYSTEM WEIGHT 130 kg (permissible total weight)
WEIGHT 16,1 kg (without pedals)



■ faded blue (orange)

- 🔪 020104103 PROWLER 292 S / 43cm
- 🔪 020104108 PROWLER 292 M / 48cm
- 🔪 020104113 PROWLER 292 L / 53cm

WHERE WE'RE GOING WE DON'T NEED ROADS.



SCARP MT

PRESTIGE



Unterschätze nie den Einfluss von mehr Federweg am Race Fully.

MT steht für Marathon und eröffnet ein neues Bike-Segment in der KTM Produktpalette. Das SCARP MT verbindet die Vorteile von mehr Federweg und dem neuen, ultraleichten 'Scarp Evo2' Race Fully Rahmen. 115 mm Federweg hinten und 120 mm vorne, geben Dir über lange Distanzen auch im

anspruchsvollen Gelände volle Kontrolle. Die „Straight-Line-Link“ Technologie macht es möglich. Zudem sorgt eine Trail lastige Ausstattung für den Genuss des extra langen Marathon Abenteuers. Ein Lenkwinkel von 67,5 Grad, genügend Platz für einen zweiten Flaschenhalter am neuen 'Scarp Evo2' Rahmen, sowie eine versenkbare Sattelstütze, runden das MT-Konzept ab.

Never underestimate the impact of more travel on a race fully.

MT stands for Marathon and creates a new bike segment in the KTM product range. The SCARP MT combines the advantages of more travel and the new, ultra-light race fully frame 'Scarp Evo2'. 115 mm rear and 120 mm front travel offers you full control for long distances even on rough terrain. The Straight-Line-Link technology makes it possible. Furthermore, a trail orientated specification ensures the pleasure of an extra-long marathon adventure. A

steering angle of 67.5 degrees, enough space for a second bottle cage on the new 'Scarp Evo2' frame, as well as a dropper seat post, wrap up the MT concept.

SCARP

MT PRESTIGE

⚙️ 1×12 SRAM
XX1 AXS

🔪 115 mm
REAR



FRAME Scarp 29" Premium Carbon
SLL115mm / M-0926

FORK RockShox SID Select RL 29" 120mm remote

SHOCK RockShox Deluxe Ultimate remote 190x45

R. DERAILL. Sram XX1 Eagle AXS 12speed

SHIFTLEV. Sram AXS Controller

CRANKSET Sram X1 Eagle DUB Carbon 32T

SPROCKET Sram X01 Eagle AXS XG1295 / 10-50

CHAIN Sram X01 Eagle 12s

BRAKE Magura MT8 Pro 2-Piston

ROTOR Rotor Storm SL.2 6L 180 / 160

WHEEL F KTM Team Trail 29 CL 110-15TA
622x30TC TLR made by DT Swiss

WHEEL R KTM Team Trail 29 CL 148-12TA
622x30TC TLR made by DT Swiss

TIRE F Maxxis Ardent Race 3C-MaxxTerra/EXO/TR 56-622

TIRE R Maxxis Ardent Race 3C-MaxxTerra/EXO/TR 56-622

GRIP KTM Team silicone

BAR KTM Prime Carbon flat 740mm

STEM KTM Prime 6"

HEADSET KTM Prime drop/in 1.1/8>1.5" +5

SADDLE Ergon SM10 Sport Men

SEATPOST RockShox Reverb AXS wireless

CATEGORY 🏍️ 3

SYSTEM WEIGHT 112 kg (permissible total weight)

WEIGHT 11.5 kg (without pedals)



■ carbon (space orange)

- 🔪 020110100 SCARP MT PRESTIGE XS / 38cm
- 🔪 020110103 SCARP MT PRESTIGE S / 43cm
- 🔪 020110108 SCARP MT PRESTIGE M / 48cm
- 🔪 020110113 SCARP MT PRESTIGE L / 53cm

MORE TRAVEL. MORE PLEASURE.



SCARP

MT PRIME

FULLY

1x12 SHIMANO XTR
115 mm REAR



FRAME Scarp 29" Premium Carbon SLL115mm / M-0926
FORK FOX 34 Float SC 29" Performance 120mm remote
SHOCK FOX Float DPS PerformanceElite remote 190x45
R. DERAILL. Shimano XTR M9100-12 SGS shadow+
SHIFTLEV. Shimano XTR M9100-12
CRANKSET Shimano XTR M9120 34T
SPROCKET Shimano XTR M9100-12 / 10-51
CHAIN Shimano XTR M9100-12

BRAKE Shimano XTR M9100 2-Piston
ROTOR Rotor MT900 CL 160 / 160 Freeza
WHEEL F KTM Team Trail 29 CL 110-15TA 622x30TC TLR made by DT Swiss
WHEEL R KTM Team Trail 29 CL 148-12TA 622x30TC TLR made by DT Swiss
TIRE F Maxxis Ardent Race 3C-MaxxTerra/EXO/TR 56-622
TIRE R Maxxis Ardent Race 3C-MaxxTerra/EXO/TR 56-622
GRIP KTM Team silicone

BAR KTM Team flat 2X 740mm
STEM KTM Team MTB 7"
HEADSET KTM Team drop/in 1.1/8>1.5" +5
SADDLE Ergon SM10 Sport Men
SEATPOST FOX Transfer Performance internal
CATEGORY 3
SYSTEM WEIGHT 120 kg (permissible total weight)
WEIGHT 11,4 kg (without pedals)



carbon satin (space orange)

- 020111100 SCARP MT PRIME XS / 38cm
- 020111103 SCARP MT PRIME S / 43cm
- 020111108 SCARP MT PRIME M / 48cm
- 020111113 SCARP MT PRIME L / 53cm

SCARP

MT MASTER

FULLY

1x12 SHIMANO DEORE XT
115 mm REAR



FRAME Scarp 29" Premium Carbon SLL115mm / M-0926
FORK FOX 34 Float SC 29" Performance 120mm remote
SHOCK FOX Float DPS PerformanceElite remote 190x45
R. DERAILL. Shimano Deore XT M8100-12 SGS shadow+
SHIFTLEV. Shimano Deore XT M8100-12
CRANKSET Shimano Deore XT M8120 32T
SPROCKET Shimano Deore XT M8100-12 / 10-51
CHAIN Shimano Deore XT M8100-12

BRAKE Shimano Deore XT M8100 2-Piston
ROTOR Rotor MT800 CL 160 / 160 Freeza
WHEEL F KTM Comp Trail 29 CL 110-15TA 622x30TC TLR made by DT Swiss
WHEEL R KTM Comp Trail 29 CL 148-12TA 622x30TC TLR made by DT Swiss
TIRE F Maxxis Ardent Race 3C-MaxxTerra/EXO/TR 56-622
TIRE R Maxxis Ardent Race 3C-MaxxTerra/EXO/TR 56-622
GRIP KTM Team silicone

BAR KTM Team flat 2X 740mm
STEM KTM Team MTB 7"
HEADSET KTM Team drop/in 1.1/8>1.5" +5
SADDLE Ergon SM10 Sport Men
SEATPOST FOX Transfer Performance internal
CATEGORY 3
SYSTEM WEIGHT 120 kg (permissible total weight)
WEIGHT 12 kg (without pedals)



carbon matt (orange)

- 020112100 SCARP MT MASTER XS / 38cm
- 020112103 SCARP MT MASTER S / 43cm
- 020112108 SCARP MT MASTER M / 48cm
- 020112113 SCARP MT MASTER L / 53cm



KTM GLORY LINE

EST. 2019





1x12 SHIMANO DEORE XT/SLX

115 mm REAR



SCARP

MT GLORY



FRAME Scarp 29" Premium Carbon-Alloy rear
SLL115mm / M-0916

FORK FOX 32 Float 29" Rhythm 120mm remote

SHOCK FOX Float DPS PerformanceElite remote 190x45

R. DERAILL. Shimano Deore XT M8100-12 SGS shadow+

SHIFTLEV. Shimano Deore XT M8100-12

CRANKSET Shimano SLX M7120 30T

SPROCKET Shimano SLX M7100-12 / 10-51

CHAIN Shimano SLX M7100-12

BRAKE Shimano SLX M7100 2-Piston

ROTOR Rotor RT70 CL 180 / 160

WHEEL F KTM Line - Shimano SLX M7110B CL 28H 110-15TA

Mavic E-XM430 28H 622x30TSS

WHEEL R KTM Line - Shimano SLX M7110B CL 28H 148-12TA

Mavic E-XM430 28H 622x30TSS

TIRE F Schwalbe Rocket Ron Perf. TLR 57-622

TIRE R Schwalbe Rocket Ron Perf. TLR 57-622

GRIP KTM Team silicone

BAR KTM Team flat 2X 740mm

STEM KTM Team MTB 7"

HEADSET KTM Team drop/in 1.1/8>1.5" +5

SADDLE Ergon SMA10 Gel Women

SEATPOST KTM Comp dropper internal w/remote

CATEGORY 3

SYSTEM WEIGHT 130 kg (permissible total weight)

WEIGHT 12,4 kg (without pedals)



eveblue (mandarin)

020113100 SCARP MT GLORY XS / 38cm

020113103 SCARP MT GLORY S / 43cm

020113108 SCARP MT GLORY M / 48cm

Inspired by

Bloomers
women in their elements

SCARP

MT ELITE

FULLY

⚙️ 1x12 SHIMANO SLX
 📏 115 mm REAR



FRAME Scarp 29" Premium Carbon-Alloy rear SLL115mm / M-0916
FORK Marzocchi Bomber Z2 29" 120mm remote
SHOCK FOX Float DPS PerformanceElite remote 190x45
R. DERAILL. Shimano SLX M7100-12 SGS shadow+
SHIFTLEV. Shimano SLX M7100-12
CRANKSET Shimano SLX M7120 32T
SPROCKET Shimano SLX M7100-12 / 10-51
CHAIN Shimano SLX M7100-12

BRAKE Shimano M6000 2-Piston
ROTOR Rotor RT54 CL 180 / 160
WHEEL F KTM Line - Shimano SLX M7110B CL 28H 110-15TA
 Mavic E-XM430 28H 622x30TSS
WHEEL R KTM Line - Shimano SLX M7110B CL 28H 148-12TA
 Mavic E-XM430 28H 622x30TSS
TIRE F Schwalbe Rocket Ron Perf. TLR 57-622
TIRE R Schwalbe Rocket Ron Perf. TLR 57-622
GRIP KTM Team silicone

BAR KTM Team flat 2X 740mm
STEM KTM Team MTB 7"
HEADSET KTM Team drop/in 1.1/8" > 1.5" +5
SADDLE Ergon SM10
SEATPOST KTM Comp dropper internal w/remote
CATEGORY 🚲 3
SYSTEM WEIGHT 130 kg (permissible total weight)
WEIGHT 12.7 kg (without pedals)



■ orange (black)

- 📏 020114100 SCARP MT ELITE XS / 38cm
- 📏 020114103 SCARP MT ELITE S / 43cm
- 📏 020114108 SCARP MT ELITE M / 48cm
- 📏 020114113 SCARP MT ELITE L / 53cm

SHIMANO

ALL GOOD THINGS COME IN THREES

12-SPEED NOW IN XTR, XT AND SLX

MAKE YOUR MARK

SHIMANO MTB

SCARP

SONIC

SLL
95mm

REMOTE
DROPPER READY

IM INTEGRATED
POSTMOUNT

BOOST
148mm

REMOTE FORK
LOCKOUT

REMOTE DAMPER
LOCKOUT

TAPERED
STEERER

PC PREMIUM
CARBON

Das SCARP SONIC bildet die Spitze unserer High End Race Fullys.

Das SCARP SONIC ist für alle gebaut, die weit über ihre Grenzen hinaus gehen wollen. Gerüstet für jegliche Rennstrecken dieser Welt, ist dieses Rad für maximale Performance und Speed ausgerichtet. 2020 kommt

das Scarp mit einem neu entwickelten Rahmen 'Scarp Evo2' und erklimmt somit die nächste Evolutionsstufe. Mit einem Gewicht von 1.580g (Größe M/48cm) ist der Evo2 Rahmen um rund 10 Prozent leichter als sein revolutionärer Vorgänger und dies bei ebenbürtigen

Steifigkeitswerten. Erzielt wurde dieser Quantensprung durch die kompromisslose Auslegung des Rahmens auf Einfach-Kettenblätter. Die „Straight-Line-Link“ Technologie garantiert, wie gewohnt, perfektes Fahrverhalten und sensibles Ansprechen des Dämpfers. Die Race-Version wartet mit 100 mm Federweg vorne und 95 mm hinten. Neben einem flacheren Lenkwinkel von 68,5 Grad, wurde der Rahmen dank Unterrohr-Formveränderung für einen zweiten Flaschenhalter optimiert. Ab sofort gibt es das SCARP auch in Größe XS (38).

The SCARP SONIC represents the pinnacle of our high end racefullys.

The SCARP SONIC is built for all who want to push their bike to the limit. The Scarp Sonic is ready to take on the worlds most spectacular race tracks. This bike is made for maximum performance and speed. In 2020, the Scarp climbs to the

next stage of evolution and will be produced with the newly developed frame 'Scarp Evo2'. With still the same stiffness values and a weight of 1.580g (size M / 48cm), the Evo2 frame is around 10 percent lighter than its revolutionary previous version. As usual, the Straight-Line-Link technology guarantees perfect

handling and sensitive response of the damper. The race version is waiting with 100 mm front and 95 mm rear travel. In addition to a flatter steering angle of 68,5 degrees, the frame has a new down tube shape, optimized for a second bottle cage for those long distance rides. Also new for 2020 the SCARP will be available in an additional size of XS / 38cm.



PHOTOCROMIC
LENSES

FAST DRYING
3D FABRIC

GOLD EDITION
PAD

100% CARBON
OUTSOLE

SCARP

SONIC

1×12 SHIMANO
XTR

95 mm
REAR



FRAME Scarp 29" Premium Carbon
SLL95mm / M-0926

FORK FOX 32 Float SC 29" Factory 100mm
(Kashima) remote

SHOCK FOX Float DPS Factory remote 190x37.5

R. DERAILL. Shimano XTR M9100-12 SGS shadow+

SHIFTLEV. Shimano XTR M9100-12

CRANKSET Shimano XTR M9120 34T

SPROCKET Shimano XTR M9100-12 / 10-51

CHAIN Shimano XTR M9100-12

BRAKE Shimano XTR M9100 2-Piston

ROTOR Rotor MT900 CL 160 / 160 Freeza

WHEEL F DT Swiss XRC 1200 Spline 25 Carbon CL 110-15TA
622x25TSS TLR

WHEEL R DT Swiss XRC 1200 Spline 25 Carbon CL 148-12TA
622x25TSS TLR

TIRE F Schwalbe Racing Ray Evo SnakeSkin TLE 57-622

TIRE R Schwalbe Racing Ralph Evo SnakeSkin TLE 57-622

GRIP KTM Team silicone

BAR KTM Prime Carbon flat 720mm

STEM KTM Prime 6°

HEADSET KTM Prime drop/in 1.1/8" > 1.5" +5

SADDLE Selle Italia X-LR Carbon

SEATPOST KTM Prime Carbon zero 30.9/400

CATEGORY 3

SYSTEM WEIGHT 110 kg (permissible total weight)

WEIGHT 9,6 kg (without pedals)



carbon (space orange)

- 020120100 SCARP SONIC XS / 38cm
- 020120103 SCARP SONIC S / 43cm
- 020120108 SCARP SONIC M / 48cm
- 020120113 SCARP SONIC L / 53cm

SCARP

PRIME

FULLY

⚙️ 1×12 SHIMANO XTR
📏 95 mm REAR



FRAME Scarp 29" Premium Carbon SLL95mm / M-0926
FORK FOX 32 Float SC 29" Performance 100mm remote
SHOCK FOX Float DPS PerformanceElite remote 190x37.5
R. DERAILL. Shimano XTR M9100-12 SGS shadow+
SHIFTLEV. Shimano XTR M9100-12
CRANKSET Shimano XTR M9120 34T
SPROCKET Shimano XTR M9100-12 / 10-51
CHAIN Shimano XTR M9100-12

DRAKE Shimano XTR M9100 2-Piston
ROTOR Rotor MT900 CL 160 / 160 Freeza
WHEEL F KTM Team CC 29 CL 110-15TA
WHEEL R KTM Team CC 29 CL 148-12TA
TIRE F Maxxis Rekon 3C-MaxxTerra EX0/TR 57-622
TIRE R Maxxis Rekon Race EX0/TR 57-622

GRIP KTM Team silicone
BAR KTM Team flat 2X 720mm
STEM KTM Team MTB 7"
HEADSET KTM Team drop/in 1.1/8>1.5" +5
SADDLE Selle Italia X-LR Mang.
SEATPOST KTM Team 30.9/400
CATEGORY 🚴 3
SYSTEM WEIGHT 110 kg (permissible total weight)
WEIGHT 10,5 kg (without pedals)



■ carbon satin (space orange)

- 📏 020121100 SCARP PRIME XS / 38cm
- 📏 020121103 SCARP PRIME S / 43cm
- 📏 020121108 SCARP PRIME M / 48cm
- 📏 020121113 SCARP PRIME L / 53cm

SCARP

MASTER

FULLY

⚙️ 1×12 SHIMANO DEORE XT/SLX
📏 95 mm REAR



FRAME Scarp 29" Premium Carbon SLL95mm / M-0926
FORK FOX 32 Float SC 29" Performance 100mm remote
SHOCK FOX Float DPS PerformanceElite remote 190x37.5
R. DERAILL. Shimano Deore XT M8100-12 SGS shadow+
SHIFTLEV. Shimano Deore XT M8100-12
CRANKSET Shimano SLX M7120 34T
SPROCKET Shimano SLX M7100-12 / 10-51
CHAIN Shimano SLX M7100-12

DRAKE Shimano SLX M7100 2-Piston
ROTOR Rotor RT70 CL 180 / 160
WHEEL F KTM Comp CC 29 CL 110-15TA
WHEEL R KTM Comp CC 29 CL 148-12TA
TIRE F Maxxis Rekon 3C-MaxxTerra EX0/TR 57-622
TIRE R Maxxis Rekon Race EX0/TR 57-622

GRIP KTM Team silicone
BAR KTM Team flat 2X 720mm
STEM KTM Team MTB 7"
HEADSET KTM Team drop/in 1.1/8>1.5" +5
SADDLE Ergon SM10
SEATPOST KTM Team 30.9/400
CATEGORY 🚴 3
SYSTEM WEIGHT 110 kg (permissible total weight)
WEIGHT 11,3 kg (without pedals)



■ carbon matt (orange)

- 📏 020122100 SCARP MASTER XS / 38cm
- 📏 020122103 SCARP MASTER S / 43cm
- 📏 020122108 SCARP MASTER M / 48cm
- 📏 020122113 SCARP MASTER L / 53cm

SCARP

ELITE

FULLY

1x12 SHIMANO SLX
95 mm REAR



FRAME Scarp 29" Premium Carbon-Alloy rear SLL95mm / M-0916
FORK FOX 32 Float 29" Rhythm 100mm remote
SHOCK FOX Float DPS Performance Elite remote 190x45
R. DERAILL. Shimano SLX M7100-12 SGS shadow+
SHIFTLEV. Shimano SLX M7100-12
CRANKSET Shimano SLX M7120 34T
SPROCKET Shimano SLX M7100-12 / 10-51

CHAIN Shimano SLX M7100-12
BRAKE Shimano MT500 2-Piston
ROTOR Rotor RT54 CL 180 / 160
WHEEL F KTM Line - Shimano SLX M7110B CL 32H 110-15TA DT Swiss 533D 32H 622x22TC
WHEEL R KTM Line - Shimano SLX M7110B CL 32H 148-12TA DT Swiss 533D 32H 622x22TC
TIRE F Maxxis Rekon 3C-MaxxTerra/EX0/TR 57-622
TIRE R Maxxis Rekon Race EX0/TR 57-622

GRIP KTM Team silicone
BAR KTM Team flat 2X 720mm
STEM KTM Team MTB 7°
HEADSET KTM Team drop/in 1.1/8+1.5" +5
SADDLE Ergon SM10
SEATPOST KTM Team 30.9/400
CATEGORY 3
SYSTEM WEIGHT 130 kg (permissible total weight)
WEIGHT 12,5 kg (without pedals)



■ black matt (white)

- 020123100 SCARP ELITE XS / 38cm
- 020123103 SCARP ELITE S / 43cm
- 020123108 SCARP ELITE M / 48cm
- 020123113 SCARP ELITE L / 53cm

SCARP

294

FULLY

1x12 SRAM SX
95 mm REAR



FRAME Scarp 29" Alloy6061 triplebutted; SLL95mm / M-7936
FORK RockShox Recon RL 29" 100mm remote 15x110
SHOCK RockShox Monarch RL 165x38
R. DERAILL. Sram SX Eagle 12speed
SHIFTLEV. Sram SX Eagle Trigger
CRANKSET Sram SX Eagle DUB 34T
SPROCKET Sram SX Eagle P61210 / 11-50

CHAIN Sram NX Eagle 12s
BRAKE Shimano MT201 2-Piston
ROTOR Rotor RT54 CL 180 / 160
WHEEL F KTM Line - Shimano MT400B CL 32H 110-15TA DT Swiss 533D 32H 622x22TC
WHEEL R KTM Line - Shimano MT400B CL 32H 148-12TA DT Swiss 533D 32H 622x22TC
TIRE F Schwalbe Racing Ray Perf. TLR 57-622
TIRE R Schwalbe Racing Ralph Perf. TLR 57-622

GRIP KTM Comp Lock
BAR KTM Comp flat 2X 720mm
STEM KTM Comp 7°
HEADSET KTM Team drop/in 1.1/8+1.5" +5
SADDLE Ergon SM10
SEATPOST KTM Comp 30.9/400
CATEGORY 3
SYSTEM WEIGHT 130 kg (permissible total weight)
WEIGHT 14,3 kg (without pedals)



■ black matt (orange)

- 020124103 SCARP 294 S / 43cm
- 020124108 SCARP 294 M / 48cm
- 020124113 SCARP 294 L / 53cm



MYROON



MYROON SONIC
XTR 1*12 44-46



MYROON PRIME
XTR 1*12 47



MYROON MASTER
DEORE XT 1*12 50



MYROON GLORY
DEORE XT/SLX 1*12 59



MYROON PRO
SLX 1*12 60



MYROON COMP
SX 1*12 61



MYROON ALPHA
SLX 2*11 62

ULTRA



ULTRA 1964 PRO
DEORE XT/SLX 1*12 65



ULTRA EVO
SLX 1*12 66-69



ULTRA 1964 COMP
DEORE XT/SLX 2*11 70-72



ULTRA GLORY
SLX 1*12 73



ULTRA SPORT
SX 1*12 74



ULTRA FLITE 29 & 27
DEORE 2*10 75



ULTRA FUN 29 & 27
DEORE XT 3*9 76



ULTRA GLORIETTE 29 & 27
DEORE XT 3*9 77

CHICAGO PENNY LANE



CHICAGO DISC 29 & 27
ACERA 3*8 78



CHICAGO CLASSIC 29 & 27
ACERA 3*8 79



CHICAGO STREET 29
ACERA 3*8 80



CHICAGO STREET 27
ACERA 3*8 81



PENNY LANE DISC 27
ACERA 3*8 82



PENNY LANE CLASSIC
ACERA 3*8 83



PENNY LANE STREET
ACERA 3*8 84-85

MYROON

SONIC



Das MYROON ist der Leichtgewicht-Supersportler für den Geschwindigkeitsrausch.

Das einzige Problem am MYROON SONIC ist, damit langsam zu fahren. Sitzt du einmal auf diesem Biest, wirst du jede Sekunde versuchen, alle Möglichkeiten die es bietet, auszureizen. Steif, leicht und auf Vortrieb ausgelegt, wirst du glauben, eins mit der Maschine zu sein. Mit einem Rahmengewicht von nur 975 Gramm katapultiert sich das MYROON SONIC in die oberste Liga

der Mountainbike Hardtails. Eine Kombination aus Nano Carbon Technik und hochmodularen 40T Fasern sorgt für ein optimales Steifigkeits-Gewichtsverhältnis. Angriffslustig und doch leicht beherrschbar, begeistert das Bike auch in der Abfahrt.

The MYROON is the light weight speed hunter with super sports performance.

There's only one little problem with the MYROON SONIC, you cannot ride slowly. Once you sit on this epic mtb, you will try to out do all the possibilities it offers. Steif, light and trimmed to go forward, you'll never regret the purchase of this bike. With a frame weight of just 975 grams, the MYROON SONIC catapults itself into the top league of mountain bike hardtails. A combination of nano

carbon technology and highly modular 40T fiber ensures an optimal stiffness to weight ratio. Attractively and yet easy to control, the bike excites even on the downhill.

MYROON

SONIC

1x12 SHIMANO XTR

1x12 SHIMANO XTR

MYROON

PRIME



FRAME Myroon 29" Nano Premium Carbon M-8866

FORK FOX 32 Float SC 29" Factory 100mm (Kashima) remote

R. DERAILL. Shimano XTR M9100-12 SGS shadow+

SHIFTLEV. Shimano XTR M9100-12

CRANKSET Shimano XTR M9100 34T

SPROCKET Shimano XTR M9100-12 / 10-51

CHAIN Shimano XTR M9100-12

BRAKE Shimano XTR M9100 2-Piston

ROTOR Rotor MT900 CL 160 / 160 Freeza

WHEEL F DT Swiss XRC 1200 Spline 25 Carbon CL 110-15TA 622x25TSS TLR

WHEEL R DT Swiss XRC 1200 Spline 25 Carbon CL 148-12TA 622x25TSS TLR

TIRE F Schwalbe Racing Ray Evo SnakeSkin TLE 57-622

TIRE R Schwalbe Racing Ralph Evo SnakeSkin TLE 57-622

GRIP KTM Team silicone

BAR KTM Prime Carbon flat 720mm

STEM KTM Prime 6"

HEADSET KTM Prime drop/in 1.1/8>1.5" +5

SADDLE Selle Italia X-LR Carbon

SEATPOST KTM Prime Carbon zero 27.2/400

CATEGORY 3

SYSTEM WEIGHT 110 kg (permissible total weight)

WEIGHT 8,6 kg (without pedals)

FRAME Myroon 29" Premium Carbon / M-7876

FORK FOX 32 Float SC 29" Performance 100mm remote

R. DERAILL. Shimano XTR M9100-12 SGS shadow+

SHIFTLEV. Shimano XTR M9100-12

CRANKSET Shimano XTR M9100 34T

SPROCKET Shimano XTR M9100-12 / 10-51

CHAIN Shimano XTR M9100-12

BRAKE Shimano XTR M9100 2-Piston

ROTOR Rotor MT900 CL 160 / 160 Freeza

WHEEL F KTM Team CC 29 CL 110-15TA

WHEEL R KTM Team CC 29 CL 148-12TA

622x25TC TLR made by DT Swiss

622x25TC TLR made by DT Swiss

TIRE F Maxxis Rekon 3C-MaxxTerra/EXO/TR 57-622

TIRE R Maxxis Rekon Race EXO/TR 57-622

GRIP KTM Team silicone

BAR KTM Team flat 2X 720mm

STEM KTM Team MTB 7"

HEADSET KTM Team drop/in 1.1/8>1.5" +5

SADDLE Selle Italia X-LR Mang.

SEATPOST KTM Team 27.2/400

CATEGORY 3

SYSTEM WEIGHT 110 kg (permissible total weight)

WEIGHT 9,6 kg (without pedals)



carbon (space orange)

020130100 MYROON SONIC XS / 38cm

020130103 MYROON SONIC S / 43cm

020130108 MYROON SONIC M / 48cm

020130113 MYROON SONIC L / 53cm



carbon satin (space orange glossy)

020131100 MYROON PRIME XS / 38cm

020131103 MYROON PRIME S / 43cm

020131108 MYROON PRIME M / 48cm

020131113 MYROON PRIME L / 53cm

PHOTOCROMIC
LENSES

OPTIMAL
MOISTURE TRANSPORT

FAST DRYING
3D FABRIC



Photo: © Sportbogat.com

4 Islands Stage Race, Kroatien

MYROON

MASTER

⚙️ 1×12 SHIMANO DEORE XT

HARDTAIL



FRAME Myroon 29" Premium Carbon / M-7876
FORK FOX 32 Float SC 29" Performance 100mm remote
R. DERAILL. Shimano Deore XT M8100-12 SGS shadow+
SHIFTLEV. Shimano Deore XT M8100-12
CRANKSET Shimano Deore XT M8100 34T
SPROCKET Shimano Deore XT M8100-12 / 10-51
CHAIN Shimano Deore XT M8100-12
BRAKE Shimano Deore XT M8100 2-Piston

ROTOR Rotor MT800 CL 160 / 160 Freeza
WHEEL F KTM Comp CC 29 CL 110-15TA
 622x25TC TLR made by DT Swiss
WHEEL R KTM Comp CC 29 CL 148-12TA
 622x25TC TLR made by DT Swiss
TIRE F Maxxis Rekon 3C-MaxxTerra/EXO/TR 57-622
TIRE R Maxxis Rekon Race EXO/TR 57-622
GRIP KTM Team silicone

BAR KTM Team flat 2X 720mm
STEM KTM Team MTB 7°
HEADSET KTM Team drop/in 1.1/8>1.5" +5
SADDLE Ergon SM10
SEATPOST KTM Team 27.2/400
CATEGORY 3
SYSTEM WEIGHT 11.0 kg (permissible total weight)
WEIGHT 10.2 kg (without pedals)



carbon matt (orange)

- 020132100 MYROON MASTER XS / 38cm
- 020132103 MYROON MASTER S / 43cm
- 020132108 MYROON MASTER M / 48cm
- 020132113 MYROON MASTER L / 53cm

HARDTAIL



**KTM ist offizieller Partner
des Österreichischen
Radsportverbandes**

**KTM is official partner
of the Austrian Cycling
Federation**



UNCOMPROMISING
SHAPE

OPTIMAL
MOISTURE TRANSPORT

COMFORT
PAD

STABLE LEG
END



Erster Bloomers-Design-Thinking-Workshop bei KTM Fahrrad.

FROM WOMEN. FOR WOMEN.



Bereits in zweiter Generation wird KTM Fahrrad von starken Frauen gelenkt.

Johanna Urkauf zieht seit dem Vorjahr die Fäden des Unternehmens und rückte ihrer Mutter, Carol Urkauf-Chen, die in den Aufsichtsrat wechselte, nach.

Auf Frauenpower in der zum großen Teil Männer dominierten Fahrradbranche, setzt KTM auch bei der GLORY LINE. Dafür trafen im vergangenen Sommer beim „Bloomers - Design Thinking Workshop“, die Geschäftsführung, sowie Designer und Entwickler aus dem Hause KTM auf 13 Frauen aus der Szene, um das Thema „WOMEN ON BIKES“ nicht nur zu diskutieren, sondern spezielle Wünsche und Ansprüche, auch umzusetzen.

Das Endergebnis zeigt sich in der neuen GLORY LINE. Die Glory-Räder erstrahlen nicht nur in speziellem Design, sondern warten auch mit technischen Anpassungen. Spezielle Sättel und Griffe, kürzere Vorbauten, oder leichtere Übersetzungen sollen maximalen Fahrspaß garantieren.



NEW KTM GLORY LINE

Inspired by

Bloomers
women in their elements



ANNA WEISS
CO-FOUNDER
BLOOMERS

„Keine Lippenbekenntnisse: KTM bewies, dass es ihnen ernst ist mit den Frauen.“

Die gesamte Geschäftsführung samt aller Verantwortlicher nahm am Workshop teil. Die Offenheit, die Kritikfähigkeit und die ehrliche Neugier, mit der die KTM Manager*innen den Frauen begegneten, ist einzigartig in der Branche.“



Already in second generation, KTM Bike Industries is led by strong women.



Johanna Urkauf followed the footsteps of her mother Carol Urkauf-Chen, and is now at the helm of the company as managing director since last year.

We at KTM are proud to have Johanna Urkauf in charge and it is something quite special in the male dominated bicycle industry. Women's power is also the key word and was a key part in the thinking behind the KTM GLORY LINE. In summer last year, KTM held the Bloomers - Design Thinking Workshop, where the management, as well as designers and developers of KTM, met 13 opinion leading women who hail from the bike scene.

The aim was not only to discuss the topic of "WOMEN ON BIKES", but to realise and implement the special wishes of women as well. From this exciting meeting we can now show you the results in the new GLORY LINE: with different designs and technical adjustments like special saddles, grips, shorter stems or lighter gear ratios, we feel we have created a range of bikes women will love to ride. With comfort and design at the heart of this line, we hope all women of the world will be inspired to ride a KTM Glory.





"Small differences with a huge impact!"



"I attach particular importance to unique colouring and adapted geometry!"



"Perfectly matched specifications guarantee optimum riding pleasure!"



"In competition I can rely on my KTM bike. It has the ability to be dependable, aggressive and smooth!"



CORINA DRUML

KTM FACTORY TEAM



ANNA SPIELMANN

KTM FACTORY TEAM



ANGELIKA TANZREITER

KTM FACTORY TEAM



KATHARINA SADNIK

& HER SISTER THERESA



PROWLER GLORY

DEORE XT/SLX 1*12

18



SCARP MT GLORY

DEORE XT/SLX 1*12

30-31



MYROON GLORY

DEORE XT/SLX 1*12

59



ULTRA GLORY

SLX 1*12

73



ALTO GLORY

ULTEGRA Di2 2*11

103



X-STRADA GLORY

GRX 2*10

116

FEEL THE ORANGE FLASH



Ewige Wand, Salzkammergut

oberösterreich.at



1*12 SHIMANO DEORE XT/SLX



MYROON

GLORY



FRAME Myroon 29" Performance Carbon / M-6886
FORK FOX 32 Float 29" Rhythm
 100mm remote
R. DERAILL. Shimano Deore XT M8100-12
 SGS shadow+
SHIFTLEV. Shimano Deore XT M8100-12
CRANKSET Shimano SLX M7100 32T
SPROCKET Shimano SLX M7100-12 / 10-51
CHAIN Shimano SLX M7100-12

BRAKE Shimano SLX M7100 2-Piston
ROTOR Rotor RT70 CL 160 / 160
WHEEL F KTM Line - Shimano SLX M7110B CL 32H 110-15TA
 DT Swiss 533D 32H 622x22TC
WHEEL R KTM Line - Shimano SLX M7110B CL 32H 148-12TA
 DT Swiss 533D 32H 622x22TC
TIRE F Schwalbe Racing Ray Perf. TLR 57-622
TIRE R Schwalbe Racing Ralph Perf. TLR 57-622
GRIP KTM Team silicone

BAR KTM Team flat 2X 720mm
STEM KTM Team MTB 7°
HEADSET KTM Team drop/in 1.1/8-1.5" +5
SADDLE Ergon SMA10 Gel Women
SEATPOST KTM Team 27.2/400
MODULE NO. 020133 BG
CATEGORY 3
SYSTEM WEIGHT 121 kg (permissible total weight)
WEIGHT 11.1 kg (without pedals)



Inspired by

Bloomers
 women in their elements

eveblue (mandrin)

020133100 MYROON GLORY XS / 38cm
 020133103 MYROON GLORY S / 43cm

MYROON

PRO

⚙️ 1×12 SHIMANO SLX

⚙️ 1×12 SRAM SX

MYROON

COMP



FRAME Myroon 29" Performance Carbon / M-6886
FORK FOX 32 Float 29" Rhythm 100mm remote
R. DERAILL. Shimano SLX M7100-12 SGS shadow+
SHIFTLEV. Shimano SLX M7100-12
CRANKSET Shimano MT610 34T
SPROCKET Shimano SLX M7100-12 / 10-51
CHAIN Shimano SLX M7100-12
BRAKE Shimano MT201 2-Piston

ROTOR Rotor RT30 CL 180 / 160
WHEEL F Shimano WH-MT501-B CL 110-15TA 622x24C
WHEEL R Shimano WH-MT501-B CL 148-12TA 622x24C
TIRE F Schwalbe Rapid Rob K-Guard 57-622
TIRE R Schwalbe Rapid Rob K-Guard 57-622
GRIP KTM Team silicone

BAR KTM Team flat 2X 720mm
STEM KTM Team MTB 7°
HEADSET KTM Team drop/in 1.1/8>1.5" +5
SADDLE Ergon SM10
SEATPOST KTM Team 27.2/400
CATEGORY 3
SYSTEM WEIGHT 122 kg (permissible total weight)
WEIGHT 11,6 kg (without pedals)



FRAME Myroon 29" Performance Carbon M-6886
FORK RockShox Judy silver TK 29" 100mm remote 15x110
R. DERAILL. Sram SX Eagle 12speed
SHIFTLEV. Sram SX Eagle Trigger
CRANKSET Sram SX Eagle DUB 34T
SPROCKET Sram SX Eagle PG1210 / 11-50
CHAIN Sram NX Eagle 12s

BRAKE Shimano MT201 2-Piston
ROTOR Rotor RT30 CL 180 / 160
WHEEL F KTM Line - Shimano MT400B CL 32H 110-15TA Ryde Rival23 32H 622x23C
WHEEL R KTM Line - Shimano MT400B CL 32H 148-12TA Ryde Rival23 32H 622x23C
TIRE F Schwalbe Rapid Rob K-Guard 57-622
TIRE R Schwalbe Rapid Rob K-Guard 57-622
GRIP KTM Comp Lock

BAR KTM Comp flat 2X 720mm
STEM KTM Comp 7°
HEADSET KTM Team drop/in 1.1/8>1.5" +5
SADDLE KTM Line MTB
SEATPOST KTM Comp 27.2/400
CATEGORY 3
SYSTEM WEIGHT 122 kg (permissible total weight)
WEIGHT 12,4 kg (without pedals)



carbon matt (black glossy)

- 020134100 MYROON PRO XS / 38cm
- 020134103 MYROON PRO S / 43cm
- 020134108 MYROON PRO M / 48cm
- 020134113 MYROON PRO L / 53cm



carbon matt (white)

- 020135100 MYROON COMP XS / 38cm
- 020135103 MYROON COMP S / 43cm
- 020135108 MYROON COMP M / 48cm
- 020135113 MYROON COMP L / 53cm

MYROON

ALPHA

2x11 SHIMANO SLX

HARDTAIL



FRAME	Myroon 29" Performance Carbon M-6882
FORK	RockShox Judy silver TK 29" 100mm remote 15x110
R. DERAILL.	Shimano SLX M7000-11 GS shadow+
F. DERAILL.	Shimano SLX M7020-E sideswing
SHIFTLEV.	Shimano SLX M7000-11
CRANKSET	Shimano SLX M7000 36-26
SPROCKET	Shimano SLX M7000-11 / 11-42

CHAIN	Shimano HG601-11
BRAKE	Shimano SLX M7000 2-Piston Rotor RT30 CL 180 / 160
ROTOR	Shimano SLX M7000 2-Piston Rotor RT30 CL 180 / 160
WHEEL F	KTM Line - Shimano MT400B CL 32H 110-15TA Ryde Rival23 32H 622x23C
WHEEL R	KTM Line - Shimano MT400B CL 32H 148-12TA Ryde Rival23 32H 622x23C
TIRE F	Schwalbe Rapid Rob K-Guard 57-622
TIRE R	Schwalbe Rapid Rob K-Guard 57-622

GRIP	KTM Comp Lock
BAR	KTM Comp flat 2X 720mm
STEM	KTM Comp 7°
HEADSET	KTM Team drop/in 1.1/8>1.5" +5
SADDLE	KTM Line MTB
SEATPOST	KTM Comp 27.2/400
CATEGORY	3
SYSTEM WEIGHT	122 kg (permissible total weight)
WEIGHT	12,8 kg (without pedals)



space orange (black)

- 020136100 MYROON ALPHA XS / 38cm
- 020136103 MYROON ALPHA S / 43cm
- 020136108 MYROON ALPHA M / 48cm
- 020136113 MYROON ALPHA L / 53cm

HARDTAIL





1×12 SHIMANO DEORE XT/SLX

ULTRA

1964 PRO



FRAME Ultra 29" Alloy 6061 triplebutted; tapered headtube / M-8306
FORK FOX 32 Float 29" Rhythm 100mm remote
R. DERAILL. Shimano Deore XT M8100-12 SGS shadow+
SHIFTLEV. Shimano Deore XT M8100-12
CRANKSET Shimano Deore XT M8100 34T
SPROCKET Shimano SLX M7100-12 / 10-51
CHAIN Shimano SLX M7100-12

BRAKE Shimano MT400 2-Piston
ROTOR Rotor RT54 CL 180 / 180
WHEEL F Shimano WH-MT501-B CL 110-15TA 622x24C
TIRE F Schwalbe Rapid Rob K-Guard 57-622
TIRE R Schwalbe Rapid Rob K-Guard 57-622
GRIP KTM Comp Lock
BAR KTM Team flat 2X 720mm

STEM KTM Team MTB 7"
HEADSET KTM Team drop/in 1.1/8-1.5" +5
SADDLE Ergon SM10
SEATPOST KTM Team 27.2/400
PEDAL MTB-Pedal VP-195E alloy
CATEGORY 3
SYSTEM WEIGHT 131 kg (permissible total weight)
WEIGHT 12,5 kg (without pedals)



black matt (black + orange glossy)

- 020140100 ULTRA 1964 PRO XS / 38cm
- 020140103 ULTRA 1964 PRO S / 43cm
- 020140108 ULTRA 1964 PRO M / 48cm
- 020140113 ULTRA 1964 PRO L / 53cm
- 020140117 ULTRA 1964 PRO XL / 57cm

ULTRA EVO



REMOTE FORK
LOCKOUT

REMOTE
DROPPER POST

iM INTEGRATED
POSTMOUNT

TAPERED
STEERER

BOOST
148mm

TRIPLE BUTTED
ALLOY

Das Alu-Hardtail für mehr Action.

Mit purem Spaß kann man das Fahrgefühl auf dem EVO am Besten beschreiben. Das ULTRA EVO ist KTM's speziell konzipiertes Trail-Hardtail. Ein high end Alu-Rahmen mit

Steckachse, Boost Standard und Postmount Bremssattelaufnahme bieten die Grundlage. Dazu passend auch die Ausstattung für den breiten Einsatzbereich. Vorne stehen satte 130mm Federweg zur Verfügung. Hinten bist das Fahrwerk du. Eine versenkbare Sattelstütze und Schwalbe Nobby Nic Reifen sorgen für Sicherheit bergab.

The alloy hardtail for more action.

Pure fun is the best way to describe the riding experience on the EVO. The ULTRA EVO is KTM's specially designed hardtail suitable for the trails. A high end aluminium frame

with thru-axle, boost standard and post mount which provides the basis for your trail flow. The bike is equipped with the right equipment for a wide range of use. Rich 130mm front-travel is ready to be ridden hard. The rear suspension is all you, with a dropper seat post and Schwalbe Nobby Nic tires the Ultra Evo ensures a smooth downhill ride.

IN SEARCH FOR THE TRAILS



Bike Arena Obertraun

oberösterreich.at



1x12 SHIMANO SLX

ULTRA EVO



FRAME Ultra 29" Evo Alloy6061 triplebutted boost / M-0346
FORK RockShox Recon RL 29" 130mm 15x110
R. DERAILL. Shimano SLX M7100-12 SGS shadow+
SHIFTLEV. Shimano SLX M7100-12
CRANKSET Shimano MT610 32T
SPROCKET Shimano SLX M7100-12 / 10-51
CHAIN Shimano SLX M7100-12
ROTOR Rotor RT54 CL 180 / 180

BRAKE Shimano MT400 2-Piston
WHEEL F KTM Line - Shimano Deore M6010B CL 32H 110-15TA
Ryde Rival30 32H 622x30C
WHEEL R KTM Line - Shimano MT510B CL 32H 148-12TA
Ryde Rival30 32H 622x30C
TIRE F Schwalbe Nobby Nic Perf. TLR 60-622
TIRE R Schwalbe Nobby Nic Perf. TLR 60-622
GRIP KTM Comp Lock
BAR KTM Comp Trail35 riser 15 760mm

STEM KTM Team Trail35
HEADSET KTM Team drop/in 1.1/8>1.5" +5
SADDLE Ergon SM10
SEATPOST KTM Comp dropper internal w/remote
PEDAL MTB-Pedal VP-195E alloy
CATEGORY 3
SYSTEM WEIGHT 132 kg (permissible total weight)
WEIGHT 13,6 kg (without pedals)



■ java satin (black matt)

- 020141100 ULTRA EVO XS / 38cm
- 020141103 ULTRA EVO S / 43cm
- 020141108 ULTRA EVO M / 48cm
- 020141113 ULTRA EVO L / 53cm

ULTRA

1964 COMP

iM INTEGRATED
POSTMOUNT

**REMOTE FORK
LOCKOUT**

**INTEGRATED
CABLE ROUTING**



**INTEGRATED
KICKSTAND MOUNT**

**HEAT TREATED
ALLOY**

**Der Klassiker
der begeistert.**

Der Rahmen besteht aus hydrogeformten, dreifach konfigurierten Rohren, welche präzise Fertigung und optimale Dimensionierung ermöglichen. Das speziell geformte Oberrohr erhöht die Schrittfreiheit und somit die Fahrsicherheit in jeder Situation. Das Ultra ist

der Alu-Hardtail-Klassiker der nicht enttäuscht. Der steife Boost-Hinterbau wandelt deine Pedalkraft effizient in Fortbewegung um. In Sachen Preis-Leistung sind die ULTRA Modelle unschlagbar.

**The classic that
thrills you.**

The frame is made of hydroformed, triple-butted tubes that allows a precise manufacturing and optimal sizing. The specially shaped top tube increases the freedom of

body movement and ensures ultimate control in every situation. The Ultra is the aluminum hardtail classic that does not disappoint. The stiff boost reartriangle efficiently converts your pedaling power into motion. In terms of value for money the ULTRA models are unbeatable.

ULTRA

1964 COMP

⚙️ 2x11 SHIMANO DEORE XT/SLX



FRAME Ultra 29" AL6061 / M-8322
FORK RockShox 30 silver TK 29" 100mm remote
R. DERAILL. Shimano Deore XT M8000-11 GS shadow+
F. DERAILL. Shimano SLX M7020-H sideswing
SHIFTLEV. Shimano SLX M7000-11 w/Display
CRANKSET Shimano MT600 36-26
SPROCKET Shimano SLX M7000-11 / 11-42
CHAIN Shimano HG601-11

BRAKE Shimano MT201 2-Piston
ROTOR Rotor RT30 CL 180 / 180
WHEEL F KTM Line - Shimano Deore M6000 CL 32H 100-5QR Ryde Rival23 32H 622x230
WHEEL R KTM Line - Shimano Deore M6000 CL 32H 135-5QR Ryde Rival23 32H 622x230
TIRE F Schwalbe Rapid Rob K-Guard 57-622
TIRE R Schwalbe Rapid Rob K-Guard 57-622
GRIP KTM Comp Lock

BAR KTM Comp flat 720mm
STEM KTM Comp 7"
HEADSET Ritchey OE Logic Zero 1.1/8"
SADDLE KTM Line MTB
SEATPOST KTM Comp 27.2/400
PEDAL MTB-Pedal VP-195E alloy
CATEGORY 3
SYSTEM WEIGHT 132 kg (permissible total weight)
WEIGHT 13,9 kg (without pedals)



black matt (black+orange glossy)

- 020142103 ULTRA 1964 COMP XS / 38cm
- 020142108 ULTRA 1964 COMP S / 43cm
- 020142113 ULTRA 1964 COMP M / 48cm
- 020142117 ULTRA 1964 COMP L / 53cm

⚙️ 1x12 SHIMANO SLX



ULTRA

GLORY



FRAME Ultra 29" Alloy6061 triplebutted; tapered headtube / M-8306
FORK RockShox Judy silver TK 29" 100mm remote 15x110
R. DERAILL. Shimano SLX M7100-12 SGS shadow+
SHIFTLEV. Shimano SLX M7100-12
CRANKSET Shimano MT610 32T
SPROCKET Shimano SLX M7100-12 / 10-51
CHAIN Shimano SLX M7100-12

BRAKE Shimano MT201 2-Piston
ROTOR Rotor RT30 CL 180 / 180
WHEEL F Shimano WH-MT501-B CL 110-15TA 622x24C
WHEEL R Shimano WH-MT501-B CL 148-12TA 622x24C
TIRE F Schwalbe Rapid Rob K-Guard 57-622
TIRE R Schwalbe Rapid Rob K-Guard 57-622
GRIP KTM Comp Ergo Lock

BAR KTM Comp flat 720mm
STEM KTM Comp 7"
HEADSET KTM Team drop/in 1.1/8>1.5" +5
SADDLE Selle Italia X3 XP Lady
SEATPOST KTM Comp 27.2/400
PEDAL MTB-Pedal VP-195E alloy
CATEGORY 3
SYSTEM WEIGHT 131 kg (permissible total weight)
WEIGHT 13 kg (without pedals)



eveblue (blue+coral)

- 020143100 ULTRA GLORY XS / 38cm
- 020143103 ULTRA GLORY S / 43cm
- 020143108 ULTRA GLORY M / 48cm

Inspired by

Bloomers
women in their elements

ULTRA SPORT

⚙️ 1×12 SRAM SX

⚙️ 2×10 SHIMANO DEORE

ULTRA FLITE 29 & 27



FRAME Ultra 29" Alloy6061 triplebutted; tapered headtube / M-8306

FORK RockShox Judy silver TK 29" 100mm remote 15x110

R. DERAILL. Sram SX Eagle 12speed

SHIFTLEV. Sram SX Eagle Trigger

CRANKSET Sram SX Eagle DUB 34T

SPROCKET Sram SX Eagle PG1210 / 11-50

CHAIN Sram NX Eagle 12s

BRAKE Shimano MT201 2-Piston

ROTOR Rotor RT30 CL 180 / 180

WHEEL F KTM Line - Shimano MT400B CL 32H 110-15TA Ryde Rival23 32H 622x23C

WHEEL R KTM Line - Shimano MT400B CL 32H 148-12TA Ryde Rival23 32H 622x23C

TIRE F Schwalbe Rapid Rob K-Guard 57-622

TIRE R Schwalbe Rapid Rob K-Guard 57-622

GRIP KTM Comp Lock

BAR KTM Comp flat 720mm

STEM KTM Comp 7°

HEADSET KTM Team drop/in 1.1/8" > 1.5" +5

SADDLE KTM Line MTB

SEATPOST KTM Comp 27.2/400

PEDAL MTB-Pedal VP-195E alloy

CATEGORY 3

SYSTEM WEIGHT 13,2 kg (permissible total weight)

WEIGHT 13,2 kg (without pedals)

FRAME **29:** Ultra 29" AL6061 / M-8372
27: Ultra 27.5" AL6061 / M-8372

FORK **29:** Suntour XCR 32 coil 29" RL 100mm remote
27: Suntour XCR 32 coil 27.5" RL 100mm remote

R. DERAILL. Shimano Deore M6000-10 GS shadow+

F. DERAILL. Shimano Deore M6020-H sideswing

SHIFTLEV. Shimano Deore M6000-10 w/Display

CRANKSET Shimano MT500 36-26

SPROCKET Shimano Deore HG500-10 / 11-42

CHAIN Shimano HG54-10

DRAKE Shimano MT200 2-Piston

ROTOR Rotor RT10 CL 180 / 180

WHEEL F KTM Line - Shimano Acera M3050 CL 32H 100-5QR Ryde Rival23 32H
29: 622x23C / **27:** 584x23C

WHEEL R KTM Line - Shimano Acera M3050 CL 32H 135-5QR Ryde Rival23 32H 622x23C / 584x23C
29: 622x23C / **27:** 584x23C

TIRE F Schwalbe Rapid Rob K-Guard
29: 57-622 / **27:** 57-584

TIRE R Schwalbe Rapid Rob K-Guard
29: 57-622 / **27:** 57-584

GRIP KTM Comp Lock

BAR **29:** KTM Comp flat 720mm
27: KTM Comp rizer15 700mm

STEM KTM Comp 7°

HEADSET Ritchey OE Logic Zero 1.1/8"

SADDLE KTM Line MTB

SEATPOST **29:** KTM Comp 27.2/400
27: KTM Comp 27.2/350

PEDAL MTB-Pedal C280DU alloy

CATEGORY 3

SYSTEM WEIGHT 13,3 kg (permissible total weight)

WEIGHT 14,3 kg (without pedals)



black matt (space orange+red glossy)

- 020144103 ULTRA SPORT S / 43cm
- 020144108 ULTRA SPORT M / 48cm
- 020144113 ULTRA SPORT L / 53cm



space orange (black)

- 020146100 ULTRA FLITE 27 XS / 38cm
- 020146103 ULTRA FLITE 27 S / 43cm
- 020146108 ULTRA FLITE 27 M / 48cm



space orange (black)

- 020145103 ULTRA FLITE 29 S / 43cm
- 020145108 ULTRA FLITE 29 M / 48cm
- 020145113 ULTRA FLITE 29 L / 53cm

ULTRA

FUN 29 & 27

3x9 SHIMANO DEORE XT

3x9 SHIMANO DEORE XT



ULTRA

GLORIETTE 29 & 27



FRAME 29: 29" AL6061 MTB M8322
27: 27.5" AL6061 MTB M8372

FORK 29: 29" Suntour SF15-XCM HLO DS10
27: 27.5" Suntour SF15-XCM HLO DS10

HEADSET RITCHEY LOGIC ZERO PRESS FIT, 1-1/8", H:9.4mm

STEM KTM Comp 12"

HANDLEBAR 29: KTM Comp rizer15 720mm
27: KTM Comp rizer15 660mm

GRIP KTM Comp Lock 131mm

ROTOR Shimano RT10 CL 180 / 160

DRAKE Shimano MT200 2-Piston

CHAINWHEEL Shimano Altus MT101 40-30-22

CHAIN Shimano HG53

SPROCKET Shimano HG200-9 11-34

F. DERAILL. Shimano Alivio M4000 SS

R. DERAILL. Shimano Deore XT M772-9 SGS shadow

SHIFTER Shimano Altus SL-M201 9

F HUB Shimano HB-TX505 32HCL QR

R HUB Shimano FH-TX505 32HCL QR

SPOKE RM 2.0 INOX, silver

RIM 29: REMERX ROCKY DISC 32H 622x21
27: REMERX ROCKY DISC 32H 584x21

TIRES SCHWALBE SMART SAM K-Guard
29: 54-622 29x2.10 / 27: 54-584 27.5x2.10

SADDLE KTM Line MTB

SEATPOST KTM Comp 27.2/350

PEDAL MTB Pedal C280DU alloy

CATEGORY 3

SYSTEM WEIGHT 130 kg (permissible total weight)

WEIGHT 14,6 kg (without pedals)

FRAME 29: 29" AL6061 MTB M8312-L
27: 27.5" AL6061 MTB M8362-L

FORK 29: 29" Suntour SF19-XCM32 DS 100 15AH2
27: 27.5" Suntour SF19-XCM32 DS 100 15AH2

HEADSET KTM Team drop/in 1.1/8">1.5" +7

STEM KTM Comp 12"

HANDLEBAR 29: KTM Comp rizer15 720mm
27: KTM Comp rizer15 660mm

GRIP KTM Comp Ergo Lock

ROTOR Shimano RT10 CL 180 / 160

DRAKE Shimano MT200 2-Piston

CHAINWHEEL Shimano Altus MT101 40-30-22

CHAIN Shimano HG53

SPROCKET Shimano HG200-9 11-34

F. DERAILL. Shimano Alivio M4000 SS

R. DERAILL. Shimano Deore XT M772-9 SGS shadow

SHIFTER Shimano Altus SL-M201 9

F HUB Shimano Alivio HB-MT400B 32H CL E-Thru

R HUB Shimano Alivio FH-M405 32H CL QR

SPOKE RM 2.0 INOX, silver

RIM 29: REMERX ROCKY DISC 32H 622x21
27: REMERX ROCKY DISC 32H 584x21

TIRES SCHWALBE SMART SAM K-Guard
29: 54-622 29x2.10 / 27: 54-584 27.5x2.10

SADDLE KTM Line MTB Lady

SEATPOST KTM Comp 27.2/350

PEDAL MTB Pedal C280DU alloy

CATEGORY 2

SYSTEM WEIGHT 130 kg (permissible total weight)

WEIGHT 14,6 kg (without pedals)

black matt (grey+blue)

- 020150103 ULTRA FUN 29 S / 43cm
- 020150108 ULTRA FUN 29 M / 48cm
- 020150113 ULTRA FUN 29 L / 53cm



black matt (grey+blue)

- 020151100 ULTRA FUN 27 XS / 38cm
- 020151103 ULTRA FUN 27 S / 43cm
- 020151108 ULTRA FUN 27 M / 48cm

lightgrey matt (red+black)

- 020150133 ULTRA FUN 29 S / 43cm
- 020150138 ULTRA FUN 29 M / 48cm
- 020150143 ULTRA FUN 29 L / 53cm



lightgrey matt (red+black)

- 020151130 ULTRA FUN 27 XS / 38cm
- 020151133 ULTRA FUN 27 S / 43cm
- 020151138 ULTRA FUN 27 M / 48cm

Inspired by

Bloomers
women in their elements



deeppurple (aqua)

- 020153200 ULTRA GLORIETTE 27 XS / 35cm
- 020153202 ULTRA GLORIETTE 27 S / 42cm
- 020153207 ULTRA GLORIETTE 27 M / 47cm

deeppurple (aqua)

- 020152202 ULTRA GLORIETTE 29 S / 42cm
- 020152207 ULTRA GLORIETTE 29 M / 47cm
- 020152212 ULTRA GLORIETTE 29 L / 52cm

CHICAGO

DISC 29 & 27



3x8 SHIMANO ACERA



FRAME 29: 29" AL6061 MTB CHICAGO DISC M0572-M
27: 27.5" AL6061 MTB CHICAGO DISC M0522-M

FORK 29: 29" Suntour SF19-XCT30 HLO DS 100
27: 27.5" Suntour SF19-XCT30 HLO DS 100

HEADSET RITCHEY LOGIC ZERO PRESS FIT, 1-1/8", H:9.4mm

STEM KTM Line 7"

HANDLEBAR 29: KTM Line rizer15 720mm
27: KTM Line rizer15 660mm

GRIP KTM Dimond Grip 130mm orange ring

ROTOR Shimano RT10 CL 180 / 160

BRAKE Shimano MT200 2-Piston

CHAINWHEEL Shimano TY501 42-34-24

CHAIN Shimano HG40

SPROCKET Shimano HG31-8 11-34

F. DERAILL. Shimano M313 DS

R. DERAILL. Shimano Acra M360-8 SGS

SHIFTER Shimano Altus SL-M315 8

F HUB Shimano HB-TX505 32HCL QR

R HUB Shimano FH-TX505 32HCL QR

SPOKE RM 2.0 INOX, silver

RIM 29: REMERX ROCKY DISC 32H 622x21
27: REMERX ROCKY DISC 32H 584x21

TIRES SCHWALBE SMART SAM K-Guard
29: 54-622 29x2.10 / 27: 54-584 27.5x2.10

SADDLE KTM Line MTB

SEATPOST KTM Line 27.2/350

PEDAL MTB Pedal VPE-537 EPB

CATEGORY 2

SYSTEM WEIGHT 130 kg (permissible total weight)

WEIGHT 29: 15 kg (without pedals)
27: 14.6 kg (without pedals)

black matt (orange)

- 020155100 CHICAGO DISC 29 XS / 38cm
- 020155103 CHICAGO DISC 29 S / 43cm
- 020155108 CHICAGO DISC 29 M / 48cm
- 020155113 CHICAGO DISC 29 L / 53cm
- 020155117 CHICAGO DISC 29 XL / 57cm



black matt (orange)

- 020156100 CHICAGO DISC 27 XS / 36cm
- 020156103 CHICAGO DISC 27 S / 43cm
- 020156108 CHICAGO DISC 27 M / 48cm
- 020156113 CHICAGO DISC 27 L / 53cm

epicgrey matt (blue)

- 020155130 CHICAGO DISC 29 XS / 38cm
- 020155133 CHICAGO DISC 29 S / 43cm
- 020155138 CHICAGO DISC 29 M / 48cm
- 020155143 CHICAGO DISC 29 L / 53cm
- 020155147 CHICAGO DISC 29 XL / 57cm



epicgrey matt (blue)

- 020156130 CHICAGO DISC 27 XS / 36cm
- 020156133 CHICAGO DISC 27 S / 43cm
- 020156138 CHICAGO DISC 27 M / 48cm
- 020156143 CHICAGO DISC 27 L / 53cm

CHICAGO

CLASSIC 29 & 27

3x8 SHIMANO ACERA



FRAME 29: 29" AL6061 MTB ULTRA CLASSIC M8432-M
27: 27.5" AL6061 MTB CHICAGO CLASSIC M8532-M

FORK 29: 29" Suntour SF18-XCE28 P 100
27: 27.5" Suntour SF18-XCE28 P 100

HEADSET RITCHEY LOGIC ZERO PRESS FIT, 1-1/8", H:9.4mm

STEM KTM Line 7"

HANDLEBAR 29: KTM Line rizer15 720mm
27: KTM Line rizer15 660mm

GRIP KTM Dimond Grip 130mm orange ring

BRAKE V TEKTRO 837AL

CHAINWHEEL Shimano TY301 42-34-24

CHAIN Shimano HG40

SPROCKET 29: Shimano HG31-8 11-34
27: Shimano HG200-8 12-32

F. DERAILL. Shimano Altus M313 DS

R. DERAILL. Shimano Acra M360-8 SGS

SHIFTER Shimano Altus ST-EF5002 8

F HUB Shimano HB-TX500 32H QR

R HUB Shimano FH-TX500 32H QR

SPOKE RM 2.0 INOX, silver

RIM 29: REMERX DRAGON 32H 622x19
27: REMERX DRAGON 32H 584x19

TIRES IMPAC SMARTPAC TwinSkin
29: 54-622 29x2.10 / 27: 54-584 27.5x2.10

SADDLE KTM Line MTB

SEATPOST KTM Line 27.2/350

PEDAL MTB Pedal VPE-537 EPB

CATEGORY 2

SYSTEM WEIGHT 130 kg (permissible total weight)

WEIGHT 29: 14.6 kg (without pedals)
27: 14.3 kg (without pedals)



black matt (orange)

- 020157100 CHICAGO CLASSIC 29 XS / 38cm
- 020157103 CHICAGO CLASSIC 29 S / 43cm
- 020157108 CHICAGO CLASSIC 29 M / 48cm
- 020157113 CHICAGO CLASSIC 29 L / 53cm

black matt (orange)

- 020158100 CHICAGO CLASSIC 27 XS / 36cm
- 020158103 CHICAGO CLASSIC 27 S / 43cm
- 020158108 CHICAGO CLASSIC 27 M / 48cm
- 020158113 CHICAGO CLASSIC 27 L / 53cm

CHICAGO

STREET 29

3x8 SHIMANO ACERA

3x8 SHIMANO ACERA

CHICAGO

STREET 27



FRAME 29" AL6061 MTB CHICAGO DISC M0572-M
FORK 29" Suntour SF18-XCT-ATB DS 100
HEADSET RITCHEY LOGIC ZERO PRESS FIT, 1-1/8", H:9.4mm
STEM KTM Line 7"
HANDLEBAR KTM Line rizer15 720mm
GRIP KTM Dimond Grip 130mm black ring
ROTOR Shimano RT10 CL 180 / 160
DRAKE Shimano EF505 2-Piston
CHAINWHEEL Shimano TV501 42-34-24
CHAIN Shimano HG40

SPROCKET Shimano HG31-8 11-34
F. DERAILL. Shimano Altus M313 DS
R. DERAILL. Shimano Acra M360-8 SGL
F HUB Shimano 36H DH3D37 36H CL Nut
R HUB Shimano FH-TX505 36HCL QR
SPOKE RM 2.0 INOX, silver
RIM REMERX ROCKY DISC 36H 622x21
TIRES SCHWALBE SMART SAM K-Guard
SADDLE KTM Line MTB

SEATPOST KTM Line 27.2/350
PEDAL MTB Pedal VPE-537 EPB
MUDGUARD SKS VELO 29 65 MOUNTAIN
KICKSTAND KTM REAR 26-29" adjust
F LIGHTING AXA COMPACTLINE LED 20Lux
R LIGHTING SPANNINGA PIXEO
CATEGORY 2
SYSTEM WEIGHT 130 kg (permissible total weight)
WEIGHT 16,5 kg (without pedals)

FRAME 27.5" AL6061 MTB CHICAGO STREET M8562-M
FORK 27.5" Suntour SF18-XCE28 P 80
HEADSET RITCHEY LOGIC ZERO PRESS FIT, 1-1/8", H:9.4mm
STEM KTM Line 12"
HANDLEBAR KTM Line rizer15 640mm
GRIP KTM Dimond Grip 130mm black ring
ROTOR VTEKTRO 855AL
DRAKE Shimano TY301 42-34-24
CHAINWHEEL Shimano HG40
CHAIN Shimano HG200-8 12-32

SPROCKET Shimano Altus M313 DS
F. DERAILL. Shimano Acra M360-8 SGL
R. DERAILL. Shimano Altus ST-EF5002 8
F HUB Shimano DHC30003 36H Nut
R HUB Shimano FH-TX500 36H QR
SPOKE RM 2.0 INOX, silver
RIM REMERX DRAGON 36H 584x19
TIRES IMPAC SMARTPAC TwinSkin
SADDLE KTM Line MTB

SEATPOST KTM Line 27.2/350
PEDAL MTB Pedal VPE-537 EPB
MUDGUARD SKS VELO 27.5 65 MOUNTAIN
KICKSTAND KTM REAR 26-29" adjust
F LIGHTING AXA COMPACTLINE LED 20Lux
R LIGHTING SPANNINGA PIXEO
CATEGORY 2
SYSTEM WEIGHT 130 kg (permissible total weight)
WEIGHT 15,9 kg (without pedals)



epic grey matt (black+orange)

- 020159100 CHICAGO STREET 29 XS / 38cm
- 020159103 CHICAGO STREET 29 S / 43cm
- 020159108 CHICAGO STREET 29 M / 48cm
- 020159113 CHICAGO STREET 29 L / 53cm



croc (grey+orange)

- 020160100 CHICAGO STREET 27 XS / 36cm
- 020160103 CHICAGO STREET 27 S / 43cm
- 020160108 CHICAGO STREET 27 M / 48cm
- 020160113 CHICAGO STREET 27 L / 53cm

PENNY LANE

DISC 27

3x8 SHIMANO ACERA

3x8 SHIMANO ACERA

PENNY LANE

CLASSIC 27

HARDTAIL



FRAME 27.5" AL6061 MTB PENNY LANE DISC M0522-L
FORK 27.5" Suntour SF19-XCT30 HLO DS 100
HEADSET RITCHEY LOGIC ZERO PRESS FIT, 1-1/8", H:9.4mm
STEM KTM Line 17°
HANDLEBAR KTM Line rizer15 640mm
GRIP KTM Dimond Grip 130mm black ring
ROTOR Shimano RT10 CL 180 / 160
BRAKE Shimano MT200 2-Piston
CHAINWHEEL Shimano TY501 42-34-24

CHAIN Shimano HG40
SPROCKET Shimano HG31-8 11-34
F. DERAILL. Shimano Altus M313 DS
R. DERAILL. Shimano Acra M360-8 S6SL
SHIFTER Shimano Altus SL-M315 8
F HUB Shimano HB-TX505 32HCL QR
R HUB Shimano FH-TX505 32HCL QR
SPOKE RM 2.0 INOX, silver
RIM REMERX ROCKY DISC 32H 584x21

TIRES SCHWALBE SMART SAM K-Guard 54-584 27.5x2.10
SADDLE KTM Line MTB Lady
SEATPOST KTM Line 27.2/300
PEDAL MTB Pedal VPE-537 EPB
CATEGORY ● 2
SYSTEM WEIGHT 130 kg (permissible total weight)
WEIGHT 14,5 kg (without pedals)



FRAME 27.5" AL6061 MTB PENNY LANE CLASSIC M8532-L
FORK 27.5" Suntour SF18-XCE28 P 100
HEADSET RITCHEY LOGIC ZERO PRESS FIT, 1-1/8", H:9.4mm
STEM KTM Line 17°
HANDLEBAR KTM Line rizer15 640mm
GRIP KTM Dimond Grip 130mm white ring
BRAKE VTEKTRO 837AL
CHAINWHEEL Shimano TY301 42-34-24

CHAIN Shimano HG40
SPROCKET Shimano HG200-8 12-32
F. DERAILL. Shimano Altus M313 DS
R. DERAILL. Shimano Acra M360-8 S6SL
SHIFTER Shimano Altus ST-EF5002 8
F HUB Shimano HB-TX500 32H QR
R HUB Shimano FH-TX500 32H QR
SPOKE RM 2.0 INOX, silver

RIM REMERX DRAGON 32H 584x19
TIRES IMPAC SMARTPAC TwinSkin 54-584 27.5x2.10
SADDLE KTM Line MTB Lady
SEATPOST KTM Line 27.2/300
PEDAL MTB Pedal VPE-537 EPB
CATEGORY ● 2
SYSTEM WEIGHT 130 kg (permissible total weight)
WEIGHT 14,3 kg (without pedals)



indianred (eveblue + mandarin)

rose (grey)

- 📌 020161200 PENNY LANE DISC 27 XS / 35cm
- 📌 020161202 PENNY LANE DISC 27 S / 42cm
- 📌 020161207 PENNY LANE DISC 27 M / 47cm
- 📌 020161212 PENNY LANE DISC 27 L / 52cm

- 📌 020161230 PENNY LANE DISC 27 XS / 35cm
- 📌 020161232 PENNY LANE DISC 27 S / 42cm
- 📌 020161237 PENNY LANE DISC 27 M / 47cm
- 📌 020161242 PENNY LANE DISC 27 L / 52cm

white (eveblue + aqua)

- 📌 020162200 PENNY LANE CLASSIC 27 XS / 35cm
- 📌 020162202 PENNY LANE CLASSIC 27 S / 42cm
- 📌 020162207 PENNY LANE CLASSIC 27 M / 47cm

PENNY LANE

STREET 27

3x8 SHIMANO ACERA

HARDTAIL



FRAME	27.5" AL6061 MTB PENNY LANE STREET M8562-L
FORK	27.5" Suntour SF18-XCE28 P 80
HEADSET	RITCHEY LOGIC ZERO PRESS FIT, 1-1/8", H:9.4mm
STEM	KTM Line 17"
HANDLEBAR	KTM Line rizer15 640mm
GRIP	KTM Dimond Grip 130mm white ring
BRAKE	V TEKTRO 855AL
CHAINWHEEL	Shimano TY301 42-34-24
CHAIN	Shimano HG40

SPROCKET	Shimano HG200-8 12-32
F. DERAILL.	Shimano Altus M313 DS
R. DERAILL.	Shimano Acra M360-8 SGL
SHIFTER	Shimano Altus ST-EF5002 8
F HUB	Shimano DHC30003 36H Nut
R HUB	Shimano FH-TX500 36H QR
SPOKE	RM 2.0 INOX, silver
RIM	REMERX DRAGON 36H 584x19
TIRES	IMPAC SMARTPAC TwinSkin 54-584 27.5x2.10

SADDLE	KTM Line MTB Lady
SEAT POST	KTM Line 27.2/300
PEDAL	MTB Pedal VPE-537 EPB
MUDGUARD	SKS VELO 27.5 65 MOUNTAIN
KICKSTAND	KTM REAR 26-29" adjust
F LIGHTING	AXA COMPACTLINE LED 20Lux
R LIGHTING	SPANNINGA PIXEO
CATEGORY	2
SYSTEM WEIGHT	130 kg (permissible total weight)
WEIGHT	15.6 kg (without pedals)



lightgrey (rose)

- 020163200 PENNY LANE STREET 27 XS / 35cm
- 020163202 PENNY LANE STREET 27 S / 42cm
- 020163207 PENNY LANE STREET 27 M / 47cm

HARDTAIL





REVELATOR LISSE



REVELATOR LISSE SONIC
RED ETAP AXS 2*12 88-91



REVELATOR LISSE PRESTIGE
DURA ACE Di2 2*11 93



REVELATOR LISSE MASTER
ULTEGRA Di2 2*11 94



REVELATOR LISSE ELITE
105 2*11 95

REVELATOR ALTO



REVELATOR ALTO SONIC
DURA ACE Di2 2*11 98-101



REVELATOR ALTO MASTER
ULTEGRA Di2 2*11 102



REVELATOR ALTO GLORY
ULTEGRA Di2 2*11 103



REVELATOR ALTO ELITE
105 2*11 104



REVELATOR ALTO PRO
105 2*11 105

REVELATOR 4000 / STRADA



REVELATOR 4000
105 2*11 106



STRADA 1000
TIAGRA 2*10 107

X-STRADA



X-STRADA 710
GRX 2*11 108-110



X-STRADA 720
GRX 2*10 111



X-STRADA LFC
GRX 2*10 112-115



X-STRADA GLORY
GRX 2*10 116

REVELATOR

LISSE

SONIC

PC PREMIUM
CARBONAERO
SEATPOSTASYMMETRIC
FRAME SHAPEiFM INTEGRATED
FLATMOUNT

Minimaler Luftwiderstand für neue Geschwindigkeitsrekorde

Internationale Rennerfolge bestätigen die perfekte Arbeit unserer Ingenieure. Das REVELATOR LISSE ist bis ins kleinste Detail auf Aerodynamik ausgelegt und bringt dich auf Antrieb in den Geschwindigkeitsrausch. Nach intensiver Entwicklungsarbeit wurde ein perfektes Konzept auf die Beine gestellt. Maßstäbe in der Aeroklasse setzt das Rahmengewicht von unter

1000 Gramm. Durch die Asymmetrie des Unterrohrs wird der Luftstrom auf die aerodynamisch günstigere, linke Seite des Hinterbaus gelenkt. Besonders sticht das Rad durch die Vollintegration der Züge hervor. Die Bremsleitungen verlaufen direkt durch den Vorbau und die Gabel in den Rahmen. Hervorzuheben ist, dass beim LISSE auch die Züge einer mechanischen Schaltung komplett integriert werden.

Als Alleinstellungsmerkmale gilt das KTM entwickelte, abnehmbare Vorbau-Oberteil, das die Arbeit an den Leitungen wesentlich vereinfacht. Spezielle Spacer ermöglichen eine rasche Veränderung des Vorbauwinkels, und nehmen Wartungs- und Anpassungsarbeiten den Schrecken. Neu am LISSE SONIC ist die SRAM eTAP AXS 12speed Schaltung.

Minimal wind resistance to achieve your personal bests.

International race victories confirm the perfect work of our engineers. Down to the smallest details, the REVELATOR LISSE is made for perfect aerodynamics and takes you

right into speed rush. After intensive development work, a perfect concept with a benchmark frame weight below 1000 gram was set up. Thanks to an asymmetric down tube, the airstream is led to the more aerodynamical left side of the rear frame end. Outstanding

the fully integrated cable routing. The brake wires run straight through the stem and fork into the frame. Even a mechanical drive train can be completely integrated. A unique feature is the KTM developed removable stem upper part that significantly simplifies the work on the cables. Special spacers allow a quick variation of the stem angle and make maintenance and adjustment work just easy. New on the LISSE Sonic is the SRAM eTAP AXS 12speed drivetrain.



2x12 SRAM RED eTAP AXS

REVELATOR LISSE

SONIC



FRAME Revelator Lisse Aero-Design Premium Carbon / R-7617
FORK Revelator Aero-Design Performance Carbon F11
R. DERAILL. Sram Red eTap AXS 12speed
F. DERAILL. Sram Red eTap AXS
SHIFTLEV. Sram Red eTap AXS
CRANKSET Sram Red 2x12s 48-35
SPROCKET Sram Red XG1290 / 10-28
CHAIN Sram Red D1 12s

DRAKE Sram Red 2-Piston flatmount
ROTOR Rotor Centerline XR 6L 140 / 140
WHEEL F Zipp WH404-CC Firecrest 58 Carbon 6bolt 100-12TA / 622x19TC TLR
WHEEL R Zipp WH404-CC Firecrest 58 Carbon 6bolt 142-12TA / 622x19TC TLR
TIRE F Schwalbe Pro One Evo V-Guard TLE 25-622
TIRE R Schwalbe Pro One Evo V-Guard TLE 25-622
GRIP KTM Tape anti-slip

BAR Ritchey WCS Carbon Stream II
STEM KTM Lisse Carbon
HEADSET Ritchey Road Lisse 1.1/4"
SADDLE Fizik Arione R5
SEATPOST KTM ProLink zero Carbon aero/400
CATEGORY 1
SYSTEM WEIGHT 108 kg (permissible total weight)
WEIGHT 7,6 kg (without pedals)



carbon matt (space orange glossy)

- 020170109 REVELATOR LISSE SONIC XS / 49cm
- 020170112 REVELATOR LISSE SONIC S / 52cm
- 020170115 REVELATOR LISSE SONIC M / 55cm
- 020170117 REVELATOR LISSE SONIC L / 57cm
- 020170119 REVELATOR LISSE SONIC XL / 59cm

⚙️ 2x11 SHIMANO DURA ACE Di2

REVELATOR LISSE

PRESTIGE



FRAME Revelator Lisse Aero-Design Premium Carbon / R-7614
FORK Revelator Aero-Design Performance Carbon F11
R. DERAILL. Shimano Dura Ace R9150 SS Di2
F. DERAILL. Shimano Dura Ace R9150 Di2
SHIFTLEV. Shimano Dura Ace R9170 Di2
CRANKSET Shimano Dura Ace R9100 52-36
SPROCKET Shimano Dura Ace R9100 / 11-28
CHAIN Shimano HG901-11

BRAKE Shimano Dura Ace R9170 2-Piston flatmount
ROTOR Rotor RT900 CL 140 / 140 Freeza
WHEEL F DT Swiss ARC 1400 Dicut DB 48 Carbon CL 100-12TA / 622x17TC TLR
WHEEL R DT Swiss ARC 1400 Dicut DB 48 Carbon CL 142-12TA / 622x17TC TLR
TIRE F Continental G-Prix 5000 TL 25-622
TIRE R Continental G-Prix 5000 TL 25-622
GRIP KTM Tape anti-slip

BAR Ritchey WCS Carbon Stream II
STEM KTM Lisse Carbon
HEADSET Ritchey Road Lisse 1.1/4"
SADDLE Fizik Arione R5
SEATPOST KTM ProLink zero Carbon aero/400
CATEGORY 1
SYSTEM WEIGHT 108 kg (permissible total weight)
WEIGHT 7,6 kg (without pedals)



■ white metallic (space orange)

- 🔪 020171109 REVELATOR LISSE PRESTIGE XS / 49cm
- 🔪 020171112 REVELATOR LISSE PRESTIGE S / 52cm
- 🔪 020171115 REVELATOR LISSE PRESTIGE M / 55cm
- 🔪 020171117 REVELATOR LISSE PRESTIGE L / 57cm
- 🔪 020171119 REVELATOR LISSE PRESTIGE XL / 59cm

S I M P L Y
 B E Y O N D

TODAY'S RIDERS ARE MORE CAPABLE THAN EVER. So we designed for where road is going, not simply where it's been. SRAM eTap AXS™ offers wider range and closer progression, so you're always in the right gear. A quiet, secure and smooth ride, whatever the terrain. A system that does exactly what you want, when you want. And it's still wireless. Exploring new limits has never been easier.

SRAM eTap^{AXS}

REVELATOR LISSE

MASTER

2x11 SHIMANO ULTEGRA Di2



FRAME Revelator Lisse Aero-Design Premium Carbon / R-7614
FORK Revelator Aero-Design Performance Carbon F11
R. DERAILL. Shimano Ultegra R8050 SS Di2
F. DERAILL. Shimano Ultegra R8050 Di2
SHIFTLEV. Shimano Ultegra R8070 Di2
CRANKSET Shimano Ultegra R8000 52-36
SPROCKET Shimano Ultegra R8000 / 11-28
CHAIN Shimano HG701-11

BRAKE Shimano Ultegra R8070 2-Piston flatmount
ROTOR Rotor RT800 CL 140 / 140 Freeza
WHEEL F DT Swiss PR 1600 Spline DB 32 CL100-12TA / 622x18TC TLR
WHEEL R DT Swiss PR 1600 Spline DB 32 CL 142-12TA / 622x18TC TLR
TIRE F Continental G-Prix 5000 TL 25-622
TIRE R Continental G-Prix 5000 TL 25-622
GRIP KTM Tape anti-slip

BAR Ritchey WCS Carbon Stream II
STEM KTM Lisse Carbon
HEADSET Ritchey Road Lisse 1.1/4"
SADDLE Fizik Arione R7
SEATPOST KTM ProLink zero Carbon aero/400
CATEGORY 1
SYSTEM WEIGHT 108 kg (permissible total weight)
WEIGHT 7,9 kg (without pedals)



carbon matt (space orange glossy)

020172109 REVELATOR LISSE MASTER XS / 49cm
 020172112 REVELATOR LISSE MASTER S / 52cm
 020172115 REVELATOR LISSE MASTER M / 55cm
 020172117 REVELATOR LISSE MASTER L / 57cm
 020172119 REVELATOR LISSE MASTER XL / 59cm

REVELATOR LISSE

ELITE

2x11 SHIMANO 105



FRAME Revelator Lisse Aero-Design Premium Carbon / R-7610
FORK Revelator Aero-Design Performance Carbon F11
R. DERAILL. Shimano 105 R7000 GS
F. DERAILL. Shimano 105 R7000
SHIFTLEV. Shimano 105 R7020
CRANKSET Shimano 105 R7000 50-34
SPROCKET Shimano 105 R7000 / 11-32
CHAIN Shimano HG601-11

BRAKE Shimano 105 R7070 2-Piston flatmount
ROTOR Rotor RT70 CL 160 / 160
WHEEL F DT Swiss P 1800 Spline DB 32 CL 100-12TA / 622x18TC TLR
WHEEL R DT Swiss P 1800 Spline DB 32 CL 142-12TA / 622x18TC TLR
TIRE F Schwalbe One Perf. RaceGuard TLE 25-622
TIRE R Schwalbe One Perf. RaceGuard TLE 25-622
GRIP KTM Tape anti-slip

BAR Ritchey WCS Stream
STEM KTM Lisse Carbon
HEADSET Ritchey Road Lisse 1.1/4"
SADDLE Fizik Arione R7
SEATPOST KTM CompLink zero Alloy aero/400
CATEGORY 1
SYSTEM WEIGHT 108 kg (permissible total weight)
WEIGHT 8,4 kg (without pedals)



brite red (white)

020173309 REVELATOR LISSE ELITE XS / 49cm
 020173312 REVELATOR LISSE ELITE S / 52cm
 020173315 REVELATOR LISSE ELITE M / 55cm
 020173317 REVELATOR LISSE ELITE L / 57cm
 020173319 REVELATOR LISSE ELITE XL / 59cm

**ANATOMICAL
SHAPE**

**INSIDE-OUT PAD
FOR BEST SADDLE CONTACT**

**SEAMLESS
CONSTRUCTION**

**HIGH BREATHABLE
MATERIAL**

REVELATOR

ALTO

SONIC

ASYMMETRIC
FRAME SHAPEAERO
SEATPOSTiFM INTEGRATED
FLATMOUNTNANO
PREMIUM CARBON

Von Profis getestet und bereit für den Gipfelsieg.

Berge sind bei vielen Völkern schon von frühester Zeit an sagenumwobene Orte. Symbolisch stehen Gipfel für die Sehnsucht des Menschen, zum Göttlichen empor zu klettern. In den Bergen dein Zuhause finden und

klettern wie ein junger Gott, wirst du mit dem REVELATOR ALTO SONIC bestimmt. ALTO steht abgewandelt aus dem Italienischen/Spanischen für „hoch hinaus“ und soll damit in der Namensgebung auch den Einsatz als Berggämse, inklusive seiner perfekten Abfahrteigenschaften dank Disc, widerspiegeln. Alleine der Rahmen überzeugt mit einem Gewicht von 790 Gramm. Das Steckachssystem

versteift das kompakt konstruierte hintere Rahmendreieck effektiv, um die Antrittskräfte effizient auf die Straße zu bringen. Die hohe Seitensteifigkeit der Gabel bringt Vorteile im harten Wiegetritt. Ein asymmetrisch gestalteter Tretlagerbereich, sowie Hinterbau, gewährleisten maximale Effizienz bei starker Krafteinwirkung. Eine auch innen glatte und faltenfreie Oberfläche des Rahmens garantiert die Effizienz jeder einzelnen Carbonfaser.

Pro tested and ready to become king of the mountains.

Since the beginning of time, mountains are seen as legendary places. Symbolically, peaks stand for the yearning of man for climbing up to the divine. The REVELATOR

ALTO SONIC definitely makes you climb like a young god and let you find your home in the mountains. Translated from the Italian / Spanish language, ALTO stands for "high out", what reflects the bike's favourite terrain. Thanks to the discbrakes, it also provides the perfect descent skills. The frame alone convinces with a weight of 790 grams. The thru axle system effectively

stiffens the compactly designed rear triangle to bring all power on the road. The high lateral stiffness of the fork brings advantages when you push hard out of the saddle. An asymmetric bottom bracket area and rear frame section guarantee maximum efficiency under high force. A smooth and wrinkle-free inner-surface of the frame guarantees the efficiency of every single carbon fiber.

LEAVE THE VALLEY BEHIND



Gaisberg, Salzburg

2x11 SHIMANO
DURA ACE Di2

REVELATOR ALTO SONIC



FRAME Revelator Alto Nano Premium Carbon R-9814

FORK Revelator Alto Premium Carbon F12

R. DERAILL. Shimano Dura Ace R9150 SS Di2

F. DERAILL. Shimano Dura Ace R9150 Di2

SHIFTLEV. Shimano Dura Ace R9170 Di2

CRANKSET Shimano Dura Ace R9100 52-36

SPROCKET Shimano Dura Ace R9100 / 11-28

CHAIN Shimano HG901-11

BRAKE Shimano Dura Ace R9170 2-Piston flatmount

ROTOR Rotor RT900 CL 140 / 140 Freeza

WHEEL F DT Swiss PRC 1400 Spline DB 35 Carbon CL 100-12TA / 622x18TC TLR

WHEEL R DT Swiss PRC 1400 Spline DB 35 Carbon CL 142-12TA / 622x18TC TLR

TIRE F Schwalbe Pro One Evo V-Guard TLE 25-622

TIRE R Schwalbe Pro One Evo V-Guard TLE 25-622

GRIP KTM Tape anti-slip

BAR Ritchey WCS Carbon Stream II

STEM Ritchey WCS Chicane 10°

HEADSET KTM Team Road drop/in 1.1/8>1.1/4"

SADDLE Fizik Antares R5

SEATPOST KTM ProLink zero Carbon aero/400

CATEGORY 1

SYSTEM WEIGHT 111 kg (permissible total weight)

WEIGHT 6,8 kg (without pedals)



carbon matt (space orange glossy)

020175109 REVELATOR ALTO SONIC XS / 49cm

020175112 REVELATOR ALTO SONIC S / 52cm

020175115 REVELATOR ALTO SONIC M / 55cm

020175117 REVELATOR ALTO SONIC L / 57cm

020175119 REVELATOR ALTO SONIC XL / 59cm

REVELATOR ALTO

MASTER

2x11 SHIMANO ULTEGRA Di2

2x11 SHIMANO ULTEGRA Di2



REVELATOR ALTO

GLORY



FRAME	Revelator Alto Premium Carbon R-9824
FORK	Revelator Alto Performance Carbon F12
R. DERAILL.	Shimano Ultegra R8050 SS Di2
F. DERAILL.	Shimano Ultegra R8050 Di2
SHIFTLEV.	Shimano Ultegra R8070 Di2
CRANKSET	Shimano Ultegra R8000 50-34
SPROCKET	Shimano Ultegra R8000 / 11-28
CHAIN	Shimano HG701-11

BRAKE	Shimano Ultegra R8070 2-Piston flatmount
ROTOR	Rotor RT800 CL 140 / 140 Freeza
WHEEL F	Mavic Aksium Elite Evo 22 CL 100-12TA 622x19TC TLR
WHEEL R	Mavic Aksium Elite Evo 22 CL 142-12TA 622x19TC TLR
TIRE F	Schwalbe Pro One Evo V-Guard TLE 25-622
TIRE R	Schwalbe Pro One Evo V-Guard TLE 25-622

GRIP	KTM Tape anti-slip
BAR	Ritchey WCS Stream
STEM	Ritchey WCS Chicane 10°
HEADSET	KTM Team Road drop/in 1.1/8>1.1/4"
SADDLE	Fizik Antares R5
SEATPOST	KTM CompLink zero Alloy aero/400
CATEGORY	1
SYSTEM WEIGHT	118 kg (permissible total weight)
WEIGHT	7,8 kg (without pedals)

FRAME	Revelator Alto Premium Carbon / R-9824
FORK	Revelator Alto Performance Carbon F12
R. DERAILL.	Shimano Ultegra R8050 GS Di2
F. DERAILL.	Shimano Ultegra R8050 Di2
SHIFTLEV.	Shimano Ultegra R8070 Di2
CRANKSET	Shimano Ultegra R8000 50-34
SPROCKET	Shimano 105 R7000 / 11-32
CHAIN	Shimano HG601-11

BRAKE	Shimano Ultegra R8070 2-Piston flatmount
ROTOR	Rotor RT800 CL 140 / 140 Freeza
WHEEL F	Shimano WH-RS370-TL CL 100-12TA 142-12TA / 622x19TC TLR
TIRE F	Schwalbe One Perf. RaceGuard TLE 28-622
TIRE R	Schwalbe One Perf. RaceGuard TLE 28-622
GRIP	KTM Tape anti-slip
BAR	KTM Team flare 8°

STEM	KTM Team Road 8°
HEADSET	KTM Team Road drop/in 1.1/8>1.1/4"
SADDLE	Ergon SR10 Women
SEATPOST	KTM CompLink zero Alloy aero/400
CATEGORY	1
SYSTEM WEIGHT	118 kg (permissible total weight)
WEIGHT	8,1 kg (without pedals)



white metallic (black)

- 020176309 REVELATOR ALTO MASTER XS / 49cm
- 020176312 REVELATOR ALTO MASTER S / 52cm
- 020176315 REVELATOR ALTO MASTER M / 55cm
- 020176317 REVELATOR ALTO MASTER L / 57cm
- 020176319 REVELATOR ALTO MASTER XL / 59cm



deeppurple (seafoam green)

- 020179309 REVELATOR ALTO GLORY XS / 49cm
- 020179312 REVELATOR ALTO GLORY S / 52cm
- 020179315 REVELATOR ALTO GLORY M / 55cm

Inspired by

Bloomers
women in their elements

REVELATOR ALTO

ELITE

2x11 SHIMANO 105



FRAME	Revelator Alto Premium Carbon R-9820
FORK	Revelator Alto Performance Carbon F12
R. DERAILL.	Shimano 105 R7000 GS
F. DERAILL.	Shimano 105 R7000
SHIFTLEV.	Shimano 105 R7020
CRANKSET	Shimano 105 R7000 50-34
SPROCKET	Shimano 105 R7000 / 11-32
CHAIN	Shimano HG601-11

BRAKE	Shimano 105 R7070 2-Piston flatmount
ROTOR	Rotor RT800 CL 140 / 140 Freeza
WHEEL F	DT Swiss P 1800 Spline DB 23 CL 100-12TA / 622x18TC TLR
WHEEL R	DT Swiss P 1800 Spline DB 23 CL 142-12TA / 622x18TC TLR
TIRE F	Schwalbe One Perf. RaceGuard TLE 25-622
TIRE R	Schwalbe One Perf. RaceGuard TLE 25-622

GRIP	KTM Tape anti-slip
BAR	KTM Team flare 8"
STEM	KTM Team Road 8"
HEADSET	KTM Team Road drop/in 1.1/8>1.1/4"
SADDLE	Selle Italia X3 flow
SEATPOST	KTM CompLink zero Alloy aero/400
CATEGORY	1
SYSTEM WEIGHT	118 kg (permissible total weight)
WEIGHT	8,1 kg (without pedals)



black matt (orange)

- 020177309 REVELATOR ALTO ELITE XS / 49cm
- 020177312 REVELATOR ALTO ELITE S / 52cm
- 020177315 REVELATOR ALTO ELITE M / 55cm
- 020177317 REVELATOR ALTO ELITE L / 57cm
- 020177319 REVELATOR ALTO ELITE XL / 59cm

REVELATOR ALTO

PRO

2x11 SHIMANO 105



FRAME	Revelator Alto Performance Carbon R-9830
FORK	Revelator Alto Carbon/Alloy-shaft F12
R. DERAILL.	Shimano 105 R7000 GS
F. DERAILL.	Shimano 105 R7000
CRANKSET	Shimano 105 R7020
SHIFTLEV.	Shimano RS510 50-34
SPROCKET	Shimano 105 R7000 / 11-32

CHAIN	Shimano HG601-11
BRAKE	Shimano 105 R7070 2-Piston flatmount
ROTOR	Rotor RT70 CL 160 / 160
WHEEL F	Mavic Aksium Disc 21 CL 100-12TA/622x17C
WHEEL R	Mavic Aksium Disc 21 CL 142-12TA/622x17C
TIRE F	Continental Ultra Sport II SL 25-622
TIRE R	Continental Ultra Sport II SL 25-622
GRIP	KTM Tape anti-slip

BAR	KTM Comp Road
STEM	KTM Team Road 8"
HEADSET	KTM Team Road drop/in 1.1/8>1.1/4"
SADDLE	Selle Italia X3 flow
SEATPOST	KTM CompLink zero Alloy aero/400
CATEGORY	1
SYSTEM WEIGHT	119 kg (permissible total weight)
WEIGHT	8,7 kg (without pedals)



brite red (white)

- 020178309 REVELATOR ALTO PRO XS / 49cm
- 020178312 REVELATOR ALTO PRO S / 52cm
- 020178315 REVELATOR ALTO PRO M / 55cm
- 020178317 REVELATOR ALTO PRO L / 57cm
- 020178319 REVELATOR ALTO PRO XL / 59cm

REVELATOR

4000

2x11 SHIMANO 105



FRAME	Revelator Performance Carbon / R-1485
FORK	Revelator Fork Carbon/Alloy-shaft F5
R. DERAILL.	Shimano 105 R7000 GS
F. DERAILL.	Shimano 105 R7000
SHIFTLEV.	Shimano 105 R7000
CRANKSET	Shimano RS510 50-34
SPROCKET	Shimano 105 R7000 / 11-32
CHAIN	Shimano HG601-11

DRAKE	Shimano 105 R7000
WHEEL F	Mavic Aksium 21 100-5QR/622x17C
WHEEL R	Mavic Aksium 21 135-5QR/622x17C
TIRE F	Continental Ultra Sport II SL 23-622
TIRE R	Continental Ultra Sport II SL 23-622
GRIP	KTM Tape
BAR	Ritchey COMP Road Logic II
STEM	Ritchey Comp 4-Axis 6°

HEADSET	KTM Team Road drop/in 1.1/8>1.1/4"
SADDLE	Selle Italia X3 flow
SEATPOST	Ritchey COMP 2bolt 27.2/350
CATEGORY	1
SYSTEM WEIGHT	119 kg (permissible total weight)
WEIGHT	8,6 kg (without pedals)



black metallic (space orange)

- 020180309 REVELATOR 4000 XS / 49cm
- 020180312 REVELATOR 4000 S / 52cm
- 020180315 REVELATOR 4000 M / 55cm
- 020180317 REVELATOR 4000 L / 57cm
- 020180319 REVELATOR 4000 XL / 59cm

STRADA

1000

2x10 SHIMANO TIAGRA



FRAME	Strada AL6061 / R-1302
FORK	Strada Fork Carbon/Alloy-shaft F5
R. DERAILL.	Shimano Tiagra 4700 GS
F. DERAILL.	Shimano Tiagra 4700
SHIFTLEV.	Shimano Tiagra 4700
CRANKSET	Shimano RS400 50-34
SPROCKET	Shimano Deore HG500-10 / 11-32
CHAIN	Shimano HG54-10

DRAKE	Shimano Tiagra BR-4700
WHEEL F	KTM Line - Shimano RS400 32H 100-5QR
WHEEL R	KTM Line - Shimano RS400 32H 130-5QR
TIRE F	Ryde Road Race 32H 622x16C
TIRE R	Ryde Road Race 32H 622x16C
TIRE F	Continental Ultra Sport II SL 23-622
TIRE R	Continental Ultra Sport II SL 23-622
GRIP	KTM Tape

BAR	KTM Comp Road
STEM	KTM Comp 7°
HEADSET	Ritchey Comp Road 1.1/8"
SADDLE	Selle Italia X3 flow
SEATPOST	KTM Comp 27.2/350
CATEGORY	2
SYSTEM WEIGHT	120 kg (permissible total weight)
WEIGHT	9,8 kg (without pedals)



space orange (black)

- 020185309 STRADA 1000 XS / 49cm
- 020185312 STRADA 1000 S / 52cm
- 020185315 STRADA 1000 M / 55cm
- 020185317 STRADA 1000 L / 57cm
- 020185319 STRADA 1000 XL / 59cm

X-STRADA

710

**INTEGRATED
KICKSTAND MOUNT**

**TAPERED
STEERER**

**iFM INTEGRATED
FLATMOUNT**

**TRIPLE BUTTED
ALLOY**

Das Beste aus jeder Situation herausholen.

Gravel ist nicht nur ein Trend, sondern ein ganz eigenes Gefühl Fahrrad zu fahren. Egal ob am täglichen Weg ins Büro oder auf der Mehrtagestour ans Meer, das X-STRADA wird dich sowohl auf Asphalt, als auch auf unbefestigtem Untergrund, nie im Stich lassen. Genügend Raum für breite Reifen, komfortable

Geometrie und Scheibenbremsen bringen dich immer ans Ziel. Dreifach konifizierte Rohre und kompakte Querschnitte verleihen dem Alurahmen Leichtigkeit. Nicht außer Acht gelassen wurden die spezifischen Funktionen wie Schutzblechbefestigungen und Gepäckträgeraufnahmen. Aus dieser Kombination entsteht eine sportive Optik, gepaart mit Funktionalität. Mit dem X-STRADA wirst du die Leichtigkeit des Radfahrens neu erleben. Auch in einer Glory Version oder als LFC erhältlich.

Making the most of every situation.

Gravel is not a trend, it is a memorable ride. Whether it's the everyday route into office, or a several days tour to the seaside, the X-STRADA will always be on your side, even on rough terrain. It has enough space for wide tires, comfortable geometry and disc brakes which will make your commute home as enjoyable as your leisure rides. Triple butted

tubes and compact lateral cuts give the aluminium frame its lightness. Special attention was paid to key features such as mudguards and luggage carrier mounts. This combination creates a sporty look, paired with functionality. The X-STRADA helps you to reexperience the easiness of riding a bicycle. The bike is also available in Glory and LFC version.

X-STRADA

710

⚙️ 2x11 SHIMANO GRX

⚙️ 2x10 SHIMANO GRX

X-STRADA

720

ROAD



FRAME X-Strada AL6061tb / R-0090
FORK X-Strada Gravel Carbon/Alloy-shaft F13
R. DERAILL. Shimano GRX RX810 shadow RD+
F. DERAILL. Shimano GRX RX810
SHIFTLEV. Shimano GRX RX810
CRANKSET Shimano GRX RX600-11 46-30
SPROCKET Shimano HG700-11 / 11-34
CHAIN Shimano HG601-11
DRAKE Shimano GRX RX810 2-Piston flatmount

ROTOR Rotor RT800 CL 160 / 160 Freeza
WHEEL F KTM Line - Shimano 105 R7070 CL 32H 110-12TA
 DT Swiss 533D 32H 622x22TC
WHEEL R KTM Line - Shimano 105 R7070 CL 32H 142-12TA
 DT Swiss 533D 32H 622x22TC
TIRE F Schwalbe G-One Allround Perf. RaceGuard 40-622
TIRE R Schwalbe G-One Allround Perf. RaceGuard 40-622
GRIP KTM Tape anti-slip
BAR KTM Team flare 16"

STEM KTM Team Road 8"
HEADSET KTM Team drop/in 1.1/8>1.5" +10
SADDLE Selle Italia X3 flow
SEATPOST KTM Team 27.2/350
CATEGORY 2
SYSTEM WEIGHT 129 kg (permissible total weight)
WEIGHT 10.7 kg (without pedals)



faded blue (orange)

- 📄 020190309 X-STRADA 710 XS / 49cm
- 📄 020190312 X-STRADA 710 S / 52cm
- 📄 020190315 X-STRADA 710 M / 55cm
- 📄 020190317 X-STRADA 710 L / 57cm
- 📄 020190319 X-STRADA 710 XL / 59cm



FRAME X-Strada AL6061tb / R-0090
FORK X-Strada Gravel Carbon/Alloy-shaft F13
R. DERAILL. Shimano GRX RX400 shadow RD+
F. DERAILL. Shimano GRX RX400
SHIFTLEV. Shimano GRX RX400
CRANKSET Shimano GRX RX600-10 46-30
SPROCKET Shimano Deore HG50-10 / 11-36
CHAIN Shimano HG54-10
DRAKE Shimano GRX RX400 2-Piston flatmount

ROTOR Rotor RT64 CL 160 / 160
WHEEL F KTM Line - Shimano RS470 CL 32H 100-12TA
 DT Swiss 533D 32H 622x22TC
WHEEL R KTM Line - Shimano RS470 CL 32H 142-12TA
 DT Swiss 533D 32H 622x22TC
TIRE F Schwalbe G-One Allround Perf. RaceGuard 40-622
TIRE R Schwalbe G-One Allround Perf. RaceGuard 40-622
GRIP KTM Tape anti-slip
BAR KTM Comp Road

STEM KTM Comp 7"
HEADSET KTM Team drop/in 1.1/8>1.5" +10
SADDLE Selle Italia X3 flow
SEATPOST KTM Comp 27.2/350
CATEGORY 2
SYSTEM WEIGHT 129 kg (permissible total weight)
WEIGHT 10.9 kg (without pedals)



faded red (white)

- 📄 020191309 X-STRADA 720 XS / 49cm
- 📄 020191312 X-STRADA 720 S / 52cm
- 📄 020191315 X-STRADA 720 M / 55cm
- 📄 020191317 X-STRADA 720 L / 57cm
- 📄 020191319 X-STRADA 720 XL / 59cm

X-STRADA LFC



Ein Freund der mit dir durch dick und dünn geht.

Was will man mehr? KTM bietet erstmals ein Gravelbike mit ins Gesamtbild eingearbeiteter Komplettausstattung an. Das X-STRADA LFC ist dein täglicher Begleiter und bereit für jegliche Aufgaben. Es komplettiert mit

einer hochwertigen und leichten Straßenausstattung die neue KTM Gravel Serie. Unter anderem warten eine hochwertige B+M Akkubeleuchtung und der Tubus Vega Evo Träger auf den täglichen Einsatz. Neben seinem allround und allroad Einsatzzweck begeistert das X-STRADA LFC besonders durch sein makellooses Design.

A buddy who goes through thick and thin with you.

What more could you want? For the first time, KTM offers a gravel bike with the whole package. The X-STRADA LFC is your daily companion and ready for any mission. It is produced with high quality and light weight equipment such as sleek mudguards and the Tubus Vega Evo carrier. In addition it

also includes a high-quality B + M battery lighting ready for the daily use especially on those dark nights commuting home. And lets not forget that the X-STRADA LFC also impresses with a flawless design. It really is the whole package.



X-STRADA

LFC

2x10 SHIMANO GRX

LFC
LIGHT
FENDER
CARRIER



FRAME X-Strada AL6061tb / R-0090
FORK X-Strada Gravel Carbon/Alloy-shaft F13
R. DERAILL. Shimano GRX RX400 shadow RD+
F. DERAILL. Shimano GRX RX400
SHIFTLEV. Shimano GRX RX400
CRANKSET Shimano GRX RX600-10 46-30
SPROCKET Shimano Deore HG50-10 / 11-36
CHAIN Shimano HG54-10
DRAKE Shimano GRX RX400 2-Piston flatmount
ROTOR Rotor RT64 CL 160 / 160

WHEEL F KTM Line - Shimano RS470 CL 32H 100-12TA
 DT Swiss 533D 32H 622x22TC
WHEEL R KTM Line - Shimano RS470 CL 32H 142-12TA
 DT Swiss 533D 32H 622x22TC
TIRE F Schwalbe G-One Allround Perf. RaceGuard 40-622
TIRE R Schwalbe G-One Allround Perf. RaceGuard 40-622
GRIP KTM Tape anti-slip
BAR KTM Comp Road
STEM KTM Comp 7°
HEADSET KTM Team drop/in 1.1/8-1.5" +10

SADDLE Selle Italia X3 flow
SEATPOST KTM Comp 27.2/350
CARRIER Tubus Vega Evo
LIGHT F B&M Ixon Core LED 50Lux Battery
LIGHT R B&M Toplight 2C LED Battery
CATEGORY 2
SYSTEM WEIGHT 130 kg (permissible total weight)
WEIGHT 12 kg (without pedals)



■ faded grey (white)

- ▽ 020192309 X-STRADA LFC XS / 49cm
- ▽ 020192312 X-STRADA LFC S / 52cm
- ▽ 020192315 X-STRADA LFC M / 55cm
- ▽ 020192317 X-STRADA LFC L / 57cm
- ▽ 020192319 X-STRADA LFC XL / 59cm

X-STRADA

GLORY



2x10 SHIMANO GRX

ROAD



FRAME X-Strada AL6061tb / R-0090
FORK X-Strada Gravel Carbon/Alloy-shaft F13
R. DERAILL. Shimano GRX RX400 shadow RD+
F. DERAILL. Shimano GRX RX400
SHIFTLEV. Shimano Tiagra SL-4700
CRANKSET Shimano GRX RX600-10 46-30
SPROCKET Shimano Deore HG50-10 / 11-36
CHAIN Shimano HG54-10
BRAKE Shimano RS600/405 2-Piston flatmount

ROTOR Rotor RT54 CL 160 / 160
WHEEL F KTM Line - Shimano RS470 CL 32H 100-12TA
 DT Swiss 533D 32H 622x22TC
WHEEL R KTM Line - Shimano RS470 CL 32H 142-12TA
 DT Swiss 533D 32H 622x22TC
TIRE F Schwalbe G-One Allround Perf. RaceGuard 40-622
TIRE R Schwalbe G-One Allround Perf. RaceGuard 40-622
GRIP KTM Tape anti-slip
BAR KTM Comp Mustache 550mm

STEM KTM Team Road 8°
HEADSET KTM Team drop/in 1.1/8-1.5" +10
SADDLE Selle Italia X3 XP Lady
SEATPOST KTM Comp 27.2/350
CATEGORY 2
SYSTEM WEIGHT 121 kg (permissible total weight)
WEIGHT 10,8 kg (without pedals)



■ vintage rose (deeppurple)

- ✓ 020193309 X-STRADA GLORY XS / 49cm
- ✓ 020193312 X-STRADA GLORY S / 52cm
- ✓ 020193315 X-STRADA GLORY M / 55cm
- ✓ 020193317 X-STRADA GLORY L / 57cm

Inspired by
Bloomers
 women in their elements

THE ALL IN ONE SUPERHERO

ROAD



oberösterreich.at



Halstättersee

TREKking



TREKking OFFROAD



LIFE RACE
DEORE XT 3*10 120-123



LIFE 1964 CROSS
DEORE XT/DEORE 3*10 125



LIFE ACTION
DEORE XT/DEORE 3*10 126



LIFE CROSS
DEORE XT 3*10 127



LIFE ROAD
DEORE 3*9 128



LIFE TRACK
ACERA 3*8 129



LIFE TRACK STREET
ACERA 3*8 130



LIFE ONE
ACERA 3*8 131

TREKking ONROAD



LIFE STYLE
ACERA 3*8 132-135



LIFE TOUR
ACERA 3*8 136



LIFE 8 BELT
ACERA 3*8 138



LIFE 1964
ACERA 3*8 139



LIFE FORCE
ACERA 3*8 140



LIFE LITE
ACERA 3*8 141



LIFE SPACE
DEORE 3*9 142



LIFE RIDE
ACERA 3*8 143



LIFE TIME
DEORE 3*8 144



LIFE JOY
ALTUS 3*8 145

TREKking

LIFE RACE



**INTEGRATED
POSTMOUNT**

**REMOTE FORK
LOCKOUT**

**INTEGRATED
KICKSTAND MOUNT**

**TRIPLE BUTTED
ALLOY**

Vertraue auf traditionelle Trekkingbike Kompetenz.

Am Fahrrad die Seele baumeln lassen und die Natur genießen. Für diesen Idealzustand fehlt dir nur mehr das passende KTM Trekking-Bike. Die jahrzehntelange Tradition der KTM

Trekkingräder wird angeführt vom LIFE RACE. Alle Trekking-Offroad-Modelle bieten von der Bereifung mehr Grip als die Onroad-Verwandschaft. Integrierte Kabelzüge und ein in die Gabelbrücke eingearbeiteter Frontreflektor, sorgen für ein gewohnt schönes Erscheinungsbild.

Das konische Steuerrohr erhöht die Lenkkopfsteifigkeit. Bereits verbaut ist ein Fahrradständer. Andere Features wie Licht und Schutzbleche können bei Bedarf nachgerüstet werden. Das Topmodell LIFE RACE ziert eine Shimano Deore XT Bestückung.

Trust our traditional trekking bike capability.

With the Life Bikes you can indeed relax on the bike and enjoy nature. For this maximum satisfaction you only need the right KTM trekking bike. The decades long tradition of the KTM trekking bikes is led by the LIFE RACE. All trekking off-road models are equipped with suspension fork and offer more grip than the on-road brothers. Integrated cable routing and a

front reflector, incorporated into the fork bridge ensure a beautiful appearance. The conical headtube increases the steering head stiffness. Already on the bike is a stable kick stand. Other features such as lights and fenders can be easily upgraded when needed. The top model LIFE RACE graces a Shimano Deore XT equipment.



LIFE RACE

3x10 SHIMANO DEORE XT



FRAME Trekking Offroad Alloy6061 triplebutted; tapered headtube / T-8660
FORK Suntour NCX-E air RL 63mm remote
R. DERAILL. Shimano Deore XT T8000-10 SGS shadow
F. DERAILL. Shimano Deore XT T8000-L topswing
SHIFTLEV. Shimano Deore XT T8000-10 w/Display
CRANKSET Shimano Deore XT T8000 48-36-26
SPROCKET Shimano Deore HG500-10 / 11-34
CHAIN Shimano HG95-10
BRAKE Shimano Deore XT T8000 2-Piston

ROTOR Rotor RT70 CL 180 / 160
WHEEL F KTM Line - Shimano Deore XT M8000 CL 32H 100-5QR
 Ryde Rival23 32H 622x23C
WHEEL R KTM Line - Shimano Deore XT M8000 CL 32H 135-5QR
 Ryde Rival23 32H 622x23C
TIRE F Schwalbe Smart Sam Perf. 44-622
TIRE R Schwalbe Smart Sam Perf. 44-622
GRIP Ergon GP3 SD w/Barend
DAR KTM Team flat 2X 620mm
STEM KTM Team MTB 7°

HEADSET KTM Team Trekking angle limit 1.1/8>1.5" +15
SADDLE KTM Line Cross
SEATPOST KTM Team 27.2/350
PEDAL MTB-Pedal VP-197 alloy (light)
KICKSTAND Hebie 28° adjust
CATEGORY 2
SYSTEM WEIGHT 131 kg (permissible total weight)
WEIGHT 12,6 kg (without pedals)



steelgrey matt (black+orange)

- 020200206 LIFE RACE D / 46cm
- 020200211 LIFE RACE D / 51cm

steelgrey matt (black+orange)

- 020200106 LIFE RACE H / 46cm
- 020200111 LIFE RACE H / 51cm
- 020200116 LIFE RACE H / 56cm
- 020200120 LIFE RACE H / 60cm

HIGH QUALITY SINCE AGES.



Steeg

oberösterreich.at



LIFE

1964 CROSS

3x10 SHIMANO
DEORE XT/DEORE



FRAME Trekking Offroad Alloy 6061 triplebutted; tapered headtube / T-8660
FORK Suntour NCX-E air LO 63mm
R. DERAILL. Shimano Deore XT T8000-10 SGS shadow
F. DERAILL. Shimano Deore T6000-L topswing
SHIFTLEV. Shimano Deore T6000-10 w/Display
CRANKSET Shimano Deore XT T8000 48-36-26
SPROCKET Shimano Deore HG500-10 / 11-34
CHAIN Shimano HG54-10
BRAKE Shimano MT400 2-Piston (3-Finger)

ROTOR Rotor RT64 CL 180 / 160
WHEEL F KTM Line - Shimano Deore M6000 CL 32H 100-5QR
 Ryde Rival23 32H 622x23C
WHEEL R KTM Line - Shimano Deore M6000 CL 32H 135-5QR
 Ryde Rival23 32H 622x23C
TIRE F Schwalbe Smart Sam Perf. 44-622
TIRE R Schwalbe Smart Sam Perf. 44-622
GRIP Ergon GP3 SD w/Barend
BAR KTM Comp low rizer 640mm
STEM KTM Comp 17°

HEADSET KTM Team Trekking angle limit 1.1/8-1.5" +15
SADDLE KTM Line Cross
SEATPOST KTM Comp 27.2/350
PEDAL MTB-Pedal VP-195E alloy
KICKSTAND KTM 28" adjust
CATEGORY 2
SYSTEM WEIGHT 131 kg (permissible total weight)
WEIGHT 12,8 kg (without pedals)



black matt (black+orange glossy)

- ✓ 020201106 LIFE 1964 CROSS H / 46cm
- ✓ 020201111 LIFE 1964 CROSS H / 51cm
- ✓ 020201116 LIFE 1964 CROSS H / 56cm
- ✓ 020201120 LIFE 1964 CROSS H / 60cm



black matt (black+orange glossy)

- ✓ 020201206 LIFE 1964 CROSS D / 46cm
- ✓ 020201211 LIFE 1964 CROSS D / 51cm

LIFE ACTION

OFFROAD

3x10 SHIMANO
DEORE XT/DEORE



FRAME Trekking-Off AL6061 / T-1438
FORK Suntour NCX-D air LO 63mm
R. DERAILL. Shimano Deore XT T8000-10 SGS shadow
F. DERAILL. Shimano Deore T6000-L topswing
SHIFTLEV. Shimano Deore T6000-10 w/Display
CRANKSET Shimano Deore T6010 48-36-26
SPROCKET Shimano Deore HG500-10 / 11-34
CHAIN Shimano HG54-10
BRAKE Shimano MT400 2-Piston (3-Finger)

ROTOR Rotor RT54 CL 180 / 160
WHEEL F KTM Line - Shimano Alivio M4050 CL 32H 100-5QR
 Ryde Rival23 32H 622x23C
WHEEL R KTM Line - Shimano Alivio M4050 CL 32H 135-5QR
 Ryde Rival23 32H 622x23C
TIRE F Schwalbe Smart Sam Perf. 44-622
TIRE R Schwalbe Smart Sam Perf. 44-622
GRIP Ergon GP3 SD w/Barend
BAR KTM Comp low rizer 640mm

STEM KTM Comp 17°
HEADSET Ritchey OE Logic Zero 1.1/8"
SADDLE KTM Line Cross
SEATPOST KTM Comp 27.2/350
PEDAL MTB-Pedal VP-195E alloy
KICKSTAND KTM 28" adjust
CATEGORY 2
SYSTEM WEIGHT 131 kg (permissible total weight)
WEIGHT 12,9 kg (without pedals)



black matt (grey+orange)
 ✓ 020202106 LIFE ACTION H / 46cm
 ✓ 020202111 LIFE ACTION H / 51cm
 ✓ 020202116 LIFE ACTION H / 56cm
 ✓ 020202120 LIFE ACTION H / 60cm
 ✓ 020202123 LIFE ACTION H / 63cm

black matt (grey+orange)
 ✓ 020202206 LIFE ACTION D / 46cm
 ✓ 020202211 LIFE ACTION D / 51cm
 ✓ 020202216 LIFE ACTION D / 56cm

LIFE CROSS

OFFROAD

3x10 SHIMANO
DEORE XT



FRAME 28" AL6061 OFF LIFE ACTION MAN T1438-M
FORK 28" Suntour SF20-NEX HLO DS 63
HEADSET RITCHEY LOGIC ZERO PRESS FIT, 1-1/8", H.9.4mm
STEM KTM Comp 12°
HANDLEBAR KTM Comp rizer15 640mm
GRIP ERGON GP10-BLACK 130mm
ROTOR Shimano RT30 CL 180 / 160
BRAKE Shimano MT201 2-Piston
CHAINWHEEL Shimano T521 48-36-26

CHAIN Shimano Deore HG54
SPROCKET Shimano HG501-10 11-36
F. DERAILL. Shimano Deore T6000 TS
R. DERAILL. Shimano Deore XT M781-10 GSL shadow
SHIFTER Shimano Deore SL-T6000 10
F HUB Shimano HB-TX505 32H CL QR
R HUB Shimano FH-TX505 32H CL QR
SPOKE RM 2.0 INOX, silver
RIM REMERX TOP DISC 32H 622x19

TIRES SCHWALBE SMART SAM Perf 44-622 28x1.65
SADDLE KTM Line Offroad
SEATPOST KTM Comp 27.2/350
PEDAL MTB Pedal C280DU alloy
KICKSTAND KTM REAR 26-29" adjust
CATEGORY 2
SYSTEM WEIGHT 130 kg (permissible total weight)
WEIGHT 13,8 kg (without pedals)



space orange (black)
 ✓ 020203106 LIFE CROSS H 46
 ✓ 020203111 LIFE CROSS H 51
 ✓ 020203116 LIFE CROSS H 56
 ✓ 020203120 LIFE CROSS H 60

space orange (black)
 ✓ 020203203 LIFE CROSS D 43
 ✓ 020203206 LIFE CROSS D 46
 ✓ 020203211 LIFE CROSS D 51

LIFE ROAD

⚙️ 3×9 SHIMANO DEORE



FRAME 28" AL6061 Trekking-OFF T1438
FORK 28" Suntour SF20-NEX HLO DS 63
HEADSET RITCHEY LOGIC ZERO PRESS FIT, 1-1/8", H:9.4mm
STEM KTM Line 17°
HANDLEBAR KTM Line rizer15 640mm
GRIP KTM Comp ER60 Lock 131.6mm
ROTOR Shimano RT10 CL 180 / 160
BRAKE Shimano MT200 2-Piston
CHAINWHEEL Shimano Acera T3010 48-36-26

CHAIN Shimano HG53
SPROCKET Shimano HG201-9 11-34
F. DERAILL. Shimano M370 TS
R. DERAILL. Shimano Deore M592-9 SGS shadow
SHIFTER Shimano Altus SL-M201 9
F HUB Shimano HB-TX505 32H CL QR
R HUB Shimano FH-TX505 32H CL QR
SPOKE RM 2.0 INOX, silver
RIM REMERX TOP DISC 32H 622x19

TIRES SCHWALBE SMART SAM Perf 44-622 28x1.65
SADDLE KTM Line Offroad
SEATPOST KTM Line 27.2/350
PEDAL Offroad Pedal VPE-899 EPB
KICKSTAND KTM REAR 26-29" adjust
CATEGORY ● 2
SYSTEM WEIGHT 130 kg (permissible total weight)
WEIGHT 14.1 kg (without pedals)



■ black matt (grey+blue)

- ✓ 020204106 LIFE ROAD H 46
- ✓ 020204111 LIFE ROAD H 51
- ✓ 020204116 LIFE ROAD H 56
- ✓ 020204120 LIFE ROAD H 60



■ black matt (grey+blue)

- ✓ 020204203 LIFE ROAD D 43
- ✓ 020204206 LIFE ROAD D 46
- ✓ 020204211 LIFE ROAD D 51



■ lightgrey matt (blue+mandarin)

- ✓ 020204233 LIFE ROAD D 43
- ✓ 020204236 LIFE ROAD D 46
- ✓ 020204231 LIFE ROAD D 51

LIFE TRACK

⚙️ 3×8 SHIMANO ACERA



FRAME 28" AL6061 Trekking-OFF T1438
FORK 28" Suntour SF20-NEX HLO DS 63
HEADSET RITCHEY LOGIC ZERO PRESS FIT, 1-1/8", H:9.4mm
STEM KTM Line 17°
HANDLEBAR KTM Line rizer15 640mm
GRIP KTM Comp ER60 Lock 131.6mm
ROTOR Shimano RT10 CL 180 / 160
BRAKE Shimano EF505 2-Piston
CHAINWHEEL Shimano TY501 48-38-28

CHAIN Shimano HG40
SPROCKET Shimano HG31-8 11-32
F. DERAILL. Shimano TY710 TS
R. DERAILL. Shimano Acra M360-8 SGL
F HUB Shimano HB-TX505 32H CL QR
R HUB Shimano FH-TX505 32H CL QR
SPOKE RM 2.0 INOX, silver
RIM REMERX TOP DISC 32H 622x19
TIRES SCHWALBE HURRICANE K-Guard 42-622 700x40C

SADDLE KTM Line Offroad
SEATPOST KTM Line 27.2/350
PEDAL Offroad Pedal VPE-899 EPB
KICKSTAND KTM REAR 26-29" adjust
CATEGORY ● 2
SYSTEM WEIGHT 130 kg (permissible total weight)
WEIGHT 14.1 kg (without pedals)



■ black matt (orange)

- ✓ 020205106 LIFE TRACK H 46
- ✓ 020205111 LIFE TRACK H 51
- ✓ 020205116 LIFE TRACK H 56
- ✓ 020205120 LIFE TRACK H 60



■ black matt (orange)

- ✓ 020205206 LIFE TRACK D 46
- ✓ 020205211 LIFE TRACK D 51
- ✓ 020205216 LIFE TRACK D 56



■ aqua (moon+eveblue)

- ✓ 020205233 LIFE TRACK D 43
- ✓ 020205236 LIFE TRACK D 46
- ✓ 020205241 LIFE TRACK D 51
- ✓ 020205246 LIFE TRACK D 51

LIFE

TRACK STREET

3x8 SHIMANO ACERA



FRAME	28" AL6061 Trekking-OFF T1438
FORK	28" Suntour SF20-NEX HLO DS 63
HEADSET	RITCHEY LOGIC ZERO PRESS FIT, 1-1/8", H:9.4mm
STEM	KTM Line 17°
HANDLEBAR	KTM Line rizer15 640mm
GRIP	KTM Comp ER60 Lock 131.6mm
ROTOR	Shimano RT10 CL 180 / 160
BRAKE	Shimano EF505 2-Piston
CHAINWHEEL	Shimano TY501 48-38-28
CHAIN	Shimano HG40

SPROCKET	Shimano HG31-8 11-32
F. DERAILL.	Shimano TY710 TS
R. DERAILL.	Shimano Acra M360-8 SGSL
F HUB	Shimano 36H DH3D37 32H CL QR
R HUB	Shimano FH-TX505 32H CL QR
SPOKE	RM 2.0 INOX, silver
RIM	REMERX TOP DISC 32H 622x19
TIRES	SCHWALBE HURRICANE K-Guard 42-622 700x40C
SADDLE	KTM Line Offroad

SEATPOST	KTM Line 27.2/350
PEDAL	Offroad Pedal VPE-899 EPB
MUDGUARD	SKS VELO 28 47
KICKSTAND	KTM REAR 26-29" adjust
F LIGHTING	AXA COMPACTLINE LED 20Lux
R LIGHTING	SPANNINGA PIXEO
CATEGORY	2
SYSTEM WEIGHT	130 kg (permissible total weight)
WEIGHT	15.1 kg (without pedals)



black matt (orange)

- ✓ 020206106 LIFE TRACK STREET H 46
- ✓ 020206111 LIFE TRACK STREET H 51
- ✓ 020206116 LIFE TRACK STREET H 56
- ✓ 020206120 LIFE TRACK STREET H 60

black matt (orange)

- ✓ 020206203 LIFE STREET D 43
- ✓ 020206206 LIFE STREET D 46
- ✓ 020206211 LIFE STREET D 51
- ✓ 020206216 LIFE STREET D 56

LIFE

ONE

3x8 SHIMANO ACERA



FRAME	28" AL6061 Trekking-OFF T1432
FORK	28" Suntour SF20-NEX P 63
HEADSET	RITCHEY LOGIC ZERO PRESS FIT, 1-1/8", H:9.4mm
STEM	KTM Line 17°
HANDLEBAR	KTM Line rizer15 640mm
GRIP	KTM Dimond Grip 130mm black ring
ROTOR	VTEKTRO 837AL
BRAKE	Shimano TY501 48-38-28
CHAINWHEEL	Shimano HG40

CHAIN	Shimano HG200-8 12-32
SPROCKET	Shimano TY710 TS
F. DERAILL.	Shimano Acra M360-8 SGSL
R. DERAILL.	Shimano Altus ST-EF5002 8
F HUB	Shimano HB-TX500 32H QR
R HUB	Shimano FH-TX500 32H QR
SPOKE	RM 2.0 INOX, silver
RIM	REMERX DRAGON 32H 622x19
TIRES	SCHWALBE HURRICANE K-Guard 42-622 700x40C

SADDLE	KTM Line Offroad
SEATPOST	KTM Line 27.2/300
PEDAL	Offroad Pedal VPE-899 EPB
KICKSTAND	KTM REAR 26-29" adjust
CATEGORY	2
SYSTEM WEIGHT	130 kg (permissible total weight)
WEIGHT	13,6 kg (without pedals)



epicgrey (cotto+black)

- ✓ 020207106 LIFE ONE H 46
- ✓ 020207111 LIFE ONE H 51
- ✓ 020207116 LIFE ONE H 56
- ✓ 020207120 LIFE ONE H 60

moon (indianred+cotto)

- ✓ 020207233 LIFE ONE D 43
- ✓ 020207236 LIFE ONE D 46
- ✓ 020207241 LIFE ONE D 51

LIFE STYLE



Volles Trekking Know-How seit Generationen.

Das Rad zählt nach wie vor zu den beliebtesten Fortbewegungsmitteln auf Reisen. Die Trekking-Onroad Modelle von KTM blicken dabei auf eine wahre Erfolgsgeschichte

zurück. Bewährte Qualität und Funktionalität überzeugen seit Jahrzehnten und lassen keine Wünsche offen. Bei den Trekking-Onroad Modellen, wie dem LIFE STYLE, werden sogar die Kabel der Lichtanlage in den Rahmen integriert. Hochwertig wartet das Bike mit einem Gesamtpaket wie Schutzblechen,

Ständer, Shimano Deore XT Ausstattung und robustem Gepäckträger auf. Für reichlich Komfort sorgen Federgabel und ergonomisch geformte Griffe, die das Handgelenk entspannen. Erhältlich auch in der LIFE 8 BELT Variante mit Riemenantrieb. Mit den LIFE Modellen wird der Radweg dein Wohnzimmer.

Bundled trekking know how for generations.

The KTM Life range of bikes are still one of the most popular travel companions. Therefore, KTM's trekking on-road models history is one of true success. Proven quality and functionality have been

convincing cyclists for decades and leave nothing to be desired. At the trekking on-road models, such as the LIFE STYLE, even the cables of the lighting system are fully integrated into the frame. Furthermore, the bike comes with a complete package such as fenders, kick stand, Shimano Deore XT equipment and a

robust carrier. Front suspension and ergonomic shaped grips relax the wrist and provide plenty of comfort. Also available in the LIFE 8 BELT version with belt drive. With the LIFE models the bike path is yours.



LIFE STYLE

3x10 SHIMANO DEORE XT



FRAME Trekking Onroad Alloy6061 triplebutted; tapered headtube / T-8610
FORK Suntour NCX-E air LO 63mm
R. DERAILL. Shimano Deore XT T8000-10 SGS shadow
F. DERAILL. Shimano Deore XT T8000-L topswing
SHIFTLEV. Shimano Deore XT T8000-10 w/Display
CRANKSET Shimano Deore XT T8000 48-36-26
SPROCKET Shimano Deore HG500-10 / 11-34
CHAIN Shimano HG95-10
DRAKE Shimano Deore XT T8000 2-Piston
ROTOR Rotor RT70 CL 180 / 160

WHEEL F KTM Line - Shimano hubdyn. DH-UR700 CL 32H 100-5QR
 Ryde Rival23 32H 622x23C
WHEEL R KTM Line - Shimano Deore XT M8000 CL 32H 135-5QR
 Ryde Rival23 32H 622x23C
TIRE F Schwalbe Marathon Racer Perf. RaceGuard 40-622
TIRE R Schwalbe Marathon Racer Perf. RaceGuard 40-622
GRIP Ergon GP3 SD w/Barend
BAR KTM Line rizer20 640mm
STEM KTM Line 17°
HEADSET KTM Team Trekking angle limit 1.1/8-1.5" +15
SADDLE Selle Royal Essenza

SEATPOST KTM Line 27.2/350
PEDAL Trekk. -Pedal VP-616 (anti-slip)
CARRIER KTM Racktime light (snap-it)
LIGHT F B&M Lumotec IQ-XS LED 70Lux
LIGHT R B&M Toplight 2C LED Standlight
FENDER SKS A46R 46mm black matt
CHAINGUARD Horn Catena A08 48T
KICKSTAND Hebie 28" adjust
CATEGORY 2
SYSTEM WEIGHT 133 kg (permissible total weight)
WEIGHT 14,5 kg (without pedals)



black matt (grey+orange glossy)
 ✓ 020209206 LIFE STYLE D / 46cm
 ✓ 020209211 LIFE STYLE D / 51cm

black matt (grey+orange glossy)
 ✓ 020209106 LIFE STYLE H / 46cm
 ✓ 020209111 LIFE STYLE H / 51cm
 ✓ 020209116 LIFE STYLE H / 56cm
 ✓ 020209120 LIFE STYLE H / 60cm

LIFE TOUR

⚙️ 3×10 SHIMANO DEORE XT



FRAME Trekking Onroad Alloy 6061 triplebutted; tapered headtube / T-8610
FORK Suntour NCX-E air LO 63mm
R. DERAILL. Shimano Deore XT T8000-10 SGS shadow
F. DERAILL. Shimano Deore XT T8000-L topswing
SHIFTLEV. Shimano Deore XT T8000-10 w/Display
CRANKSET Shimano Deore XT T8000 48-36-26
SPROCKET Shimano Deore HG500-10 / 11-34
CHAIN Shimano HG95-10
BRAKE Shimano MT400 2-Piston (3-Finger)
ROTOR Rotor RT64 CL 180 / 160

WHEEL F KTM Line - Shimano hubdyn. DH-UR700 CL 32H 100-5QR / Ryde Rival23 32H 622x23C
WHEEL R KTM Line - Shimano Deore XT M8000 CL 32H 135-5QR / Ryde Rival23 32H 622x23C
TIRE F Schwalbe Marathon Racer Perf. RaceGuard 40-622
TIRE R Schwalbe Marathon Racer Perf. RaceGuard 40-622
GRIP Ergon GP3 SD w/Barend
BAR KTM Line rizer20 640mm
STEM KTM Line UP3 adjust. 0-90°
HEADSET KTM Team Trekking angle limit 1.1/8"-1.5" +15
SADDLE Selle Royal Essenza

SEATPOST KTM Line Elegance suspension 27.2/300
PEDAL Trekk.-Pedal VP-616 (anti-slip)
CARRIER KTM Racktime tour (snap-it)
LIGHT F B&M Lumotec IQ-XS LED 70Lux
LIGHT R B&M Toplight 2C LED Standlight
FENDER SKS A46R 46mm black matt
CHAINGUARD Horn Catena A08 48T
KICKSTAND Hebie 28" adjust
CATEGORY 2
SYSTEM WEIGHT 133 kg (permissible total weight)
WEIGHT 15.1 kg (without pedals)



lightgrey matt (white+orange)

- ✓ 020210111 LIFE TOUR H / 51cm
- ✓ 020210116 LIFE TOUR H / 56cm
- ✓ 020210120 LIFE TOUR H / 60cm

lightgrey matt (white+orange)

- ✓ 020210206 LIFE TOUR D / 46cm
- ✓ 020210211 LIFE TOUR D / 51cm



Almdudler®
From Austria
with Love.
And Herbs.

LIFE

8 BELT

ONROAD

 1×8 SHIMANO NEXUS

FRAME Trekking Onroad Alloy6061 triplebutted; IGH belt: tapered headtube / T-9790
FORK Suntour NCX-D air LO 63mm
SHIFTLEV. Shimano Nexus 8 Revoshifter
CRANKSET Gates front-sprocket 46T
SPROCKET Gates rear-sprocket 22T
CHAIN Gates drive-belt 118T CDN
BRAKE Shimano MT200 2-Piston
ROTOR Rotor RT30 CL 180 / 160
WHEEL F KTM Line - Shimano hubdyn. DH-3D72 CL 32H 100-5QR / Ryde Rival23 32H 622x23C

WHEEL R KTM Line - Shimano Nexus 8 SG-C60018D CL 32H Ryde Rival23 32H 622x23C
TIRE F Schwalbe Marathon Racer Perf. RaceGuard 40-622
TIRE R Schwalbe Marathon Racer Perf. RaceGuard 40-622
GRIP Ergon GP1 short w/o Barend
BAR KTM Line rizer20 640mm
STEM KTM Line UP3 adjust. 0-90°
HEADSET KTM Team Trekking angle limit 1.1/8>1.5" +15
SADDLE Selle Royal Essenza
SEATPOST KTM Line suspension 27.2/300

PEDAL Trekk.-Pedal VP-616 (anti-slip)
CARRIER KTM Racktime tour (snap-it)
LIGHT F B&M Lumotec MYC LED 50Lux
LIGHT R B&M Toplight 2C LED Standlight
FENDER SKS A46R 46mm black matt
KICKSTAND KTM 28" adjust
CATEGORY  2
SYSTEM WEIGHT 134 kg (permissible total weight)
WEIGHT 16,1 kg (without pedals)



black matt (grey+orange)

- ✓ 020211111 LIFE 8 BELT H / 51cm
- ✓ 020211116 LIFE 8 BELT H / 56cm
- ✓ 020211120 LIFE 8 BELT H / 60cm
- ✓ 020211123 LIFE 8 BELT H / 63cm

black matt (grey+orange)

- ✓ 020211206 LIFE 8 BELT D / 46cm
- ✓ 020211211 LIFE 8 BELT D / 51cm
- ✓ 020211216 LIFE 8 BELT D / 56cm

black matt (grey+orange)

- ✓ 020211506 LIFE 8 BELT US / 46cm
- ✓ 020211511 LIFE 8 BELT US / 51cm
- ✓ 020211516 LIFE 8 BELT US / 56cm

LIFE

1964

ONROAD

 3×10 SHIMANO DEORE XT/DEORE

FRAME Trekking Onroad Alloy6061 triplebutted; tapered headtube / T-8610
FORK Suntour NCX-E air LO 63mm
R. DERRAIL. Shimano Deore XT T8000-10 SGS shadow
F. DERRAIL. Shimano Deore T6000-L topswing
SHIFTLEV. Shimano Deore T6000-10 w/Display
CRANKSET Shimano Deore T6010 48-36-26
SPROCKET Shimano Deore HG500-10 / 11-34
CHAIN Shimano HG54-10
BRAKE Shimano MT200 2-Piston
ROTOR Rotor RT54 CL 180 / 160

WHEEL F KTM Line - Shimano hubdyn. DH-3D72 CL 32H 100-5QR / Ryde Rival23 32H 622x23C
WHEEL R KTM Line - Shimano Deore M6000 CL 32H 135-5QR / Ryde Rival23 32H 622x23C
TIRE F Schwalbe Marathon Racer Perf. RaceGuard 40-622
TIRE R Schwalbe Marathon Racer Perf. RaceGuard 40-622
GRIP Ergon GP3 SD w/Barend
BAR KTM Line rizer20 640mm
STEM KTM Line 17°
HEADSET KTM Team Trekking angle limit 1.1/8>1.5" +15
SADDLE Selle Royal Essenza

SEATPOST KTM Line 27.2/350
PEDAL Trekk.-Pedal VP-616 (anti-slip)
CARRIER KTM Racktime light (snap-it)
LIGHT F B&M Lumotec MYC LED 50Lux
LIGHT R B&M Toplight 2C LED Standlight
FENDER SKS A46R 46mm black matt
CHAINGUARD Horn Catena 16 48T
KICKSTAND KTM 28" adjust
CATEGORY  2
SYSTEM WEIGHT 134 kg (permissible total weight)
WEIGHT 14,9 kg (without pedals)



black matt (black+orange glossy)

- ✓ 020212111 LIFE 1964 H / 51cm
- ✓ 020212116 LIFE 1964 H / 56cm
- ✓ 020212120 LIFE 1964 H / 60cm

black matt (black+orange glossy)

- ✓ 020212206 LIFE 1964 D / 46cm
- ✓ 020212211 LIFE 1964 D / 51cm
- ✓ 020212216 LIFE 1964 D / 56cm

black matt (black+orange glossy)

- ✓ 020212503 LIFE 1964 US / 43cm
- ✓ 020212506 LIFE 1964 US / 46cm
- ✓ 020212511 LIFE 1964 US / 51cm
- ✓ 020212516 LIFE 1964 US / 56cm

LIFE FORCE

3x9 SHIMANO DEORE

3x9 SHIMANO DEORE

LIFE LITE

ONROAD



FRAME Trekking-On AL6061tb / T-1455
FORK Suntour NCX-D air LO 63mm
R. DERAILL. Shimano Deore M591-9 SGS
F. DERAILL. Shimano Altus M370 topswing
SHIFTLEV. Shimano Altus M2010-9 w/Display
CRANKSET Shimano Alivio T4010 48-36-26
SPROCKET Shimano HG201-9 / 11-34
CHAIN Shimano HG53-9
BRAKE Shimano MT200 2-Piston
ROTOR Rotor RT30 CL 180 / 160

WHEEL F KTM Line - Shimano hubdyn. DH-3D72 CL 32H 100-5QR
 Ryde Rival23 32H 622x23C
WHEEL R KTM Line - Shimano Alivio M4050 CL 32H 135-5QR
 Ryde Rival23 32H 622x23C
TIRE F Schwalbe Marathon Racer Perf. RaceGuard 40-622
TIRE R Schwalbe Marathon Racer Perf. RaceGuard 40-622
GRIP Ergon GP1 SD w/o Barend
BAR KTM Line rizer20 640mm
STEM KTM Line 17°
HEADSET Ritchey OE Logic Zero 1.1/8"
SADDLE Selle Royal Essenza

SEATPOST KTM Line 27.2/350
PEDAL Trekk.-Pedal VP-616 (anti-slip)
CARRIER KTM Racktime light (snap-it)
LIGHT F B&M Lumotec MYC LED 50Lux
LIGHT R B&M Toplight 2C LED Standlight
FENDER SKS B46R 46mm black glossy
CHAINGUARD Horn Catena 16 48T
KICKSTAND KTM 28" adjust
CATEGORY ● 2
SYSTEM WEIGHT 134 kg (permissible total weight)
WEIGHT 15,3 kg (without pedals)

FRAME Trekking-On AL6061tb / T-1451
FORK Alloy Unicrown Longleg 9QR
R. DERAILL. Shimano Deore M591-9 SGS
F. DERAILL. Shimano Alivio T4000 topswing
SHIFTLEV. Shimano Alivio M4000-9 w/Display
CRANKSET Shimano Alivio T4010 48-36-26
SPROCKET Shimano HG201-9 / 11-34
CHAIN Shimano HG53-9
BRAKE Shimano Alivio T4000
WHEEL F KTM Line - Shimano hubdyn. DH-3N72
 32H 100-5QR / Ryde ZAC2000 32H 622x19C

WHEEL R KTM Line - Shimano Acera T3000 32H 135-5QR
 Ryde ZAC2000 32H 622x19C
TIRE F Schwalbe Marathon Racer
 Perf. RaceGuard 40-622
TIRE R Schwalbe Marathon Racer
 Perf. RaceGuard 40-622
GRIP Ergon GP1 SD w/o Barend
BAR KTM Line rizer20 640mm
STEM KTM Line 17°
HEADSET Ritchey OE Logic Zero 1.1/8"
SADDLE Selle Royal Essenza

SEATPOST KTM Line 27.2/350
PEDAL Trekk.-Pedal VP-616 (anti-slip)
CARRIER KTM Racktime light (snap-it)
LIGHT F B&M Lumotec MYC LED 50Lux
LIGHT R B&M Toplight 2C LED Standlight
FENDER SKS B46R 46mm black glossy
CHAINGUARD Horn Catena 16 48T
KICKSTAND KTM 28" adjust
CATEGORY ● 2
SYSTEM WEIGHT 130 kg (permissible total weight)
WEIGHT 14 kg (without pedals)



black matt (grey+blue)

- ✓ 020213106 LIFE FORCE H / 46cm
- ✓ 020213111 LIFE FORCE H / 51cm
- ✓ 020213116 LIFE FORCE H / 56cm
- ✓ 020213120 LIFE FORCE H / 60cm

black matt (grey+blue)

- ✓ 020213206 LIFE FORCE D / 46cm
- ✓ 020213211 LIFE FORCE D / 51cm
- ✓ 020213216 LIFE FORCE D / 56cm

black matt (grey+blue)

- ✓ 020213503 LIFE FORCE E / 43cm
- ✓ 020213506 LIFE FORCE E / 46cm
- ✓ 020213511 LIFE FORCE E / 51cm



white matt (grey+red)

- ✓ 020214106 LIFE LITE H / 46cm
- ✓ 020214111 LIFE LITE H / 51cm
- ✓ 020214116 LIFE LITE H / 56cm
- ✓ 020214120 LIFE LITE H / 60cm

white matt (grey+red)

- ✓ 020214206 LIFE LITE D / 46cm
- ✓ 020214211 LIFE LITE D / 51cm
- ✓ 020214216 LIFE LITE D / 56cm

white matt (grey+red)

- ✓ 020214503 LIFE LITE E / 43cm
- ✓ 020214506 LIFE LITE E / 46cm
- ✓ 020214511 LIFE LITE E / 51cm
- ✓ 020214516 LIFE LITE E / 56cm

LIFE SPACE

3x9 SHIMANO
DEORE

3x8 SHIMANO
ACERA

LIFE RIDE



FRAME 28" AL6061 Trekking-ONT1454
FORK 28" Suntour SF20-NEX HLO DS 63
HEADSET RITCHEY LOGIC ZERO PRESS FIT, 1-1/8", H:9.4mm
STEM KTM LINE COMPACT II adjust
HANDLEBAR KTM Line rizer20 640mm
GRIP ERGON GP30-BLACK
ROTOR Shimano RT30 CL 160
DRAKE Shimano MT201 2-Piston
CHAINWHEEL Shimano Alivio T4010 48-36-26
CHAIN Shimano HG53
SPROCKET Shimano HG201-9 11-34

F. DERAILL. Shimano Acera T3000 TS
R. DERAILL. Shimano deore M591-9 S6SL
SHIFTER Shimano Altus SL-M201 9
F HUB Shimano 36H DH3D37 36H CL QR
R HUB Shimano FH-TX505 36H CL QR
SPOKE RM 2.0 INOX, silver
RIM REMERX TOP DISC 32H 622x19
TIRES SCHWALBE MARATHON Green Guard 40-622 700x38C
SADDLE SELLE ROYAL Essenza
SEATPOST KTM Line 27.2/300

PEDAL Onroad Pedal VP-616 Alloy
MUDGUARD SKS PET 28 A 46 R black matt
CARRIER KTM UNIVERSAL 28" RACKTIME
KICKSTAND KTM REAR 26-29" adjust
F LIGHTING B&M LUMOTEC IQ Avy N plus LED 40Lux
R LIGHTING TRELOCK DUO FLAT
GUARD SKS CHAINBLADE
CATEGORY 2
SYSTEM WEIGHT 130 kg (permissible total weight)
WEIGHT 17,3 kg (without pedals)

FRAME 28" AL6061 Trekking-ONT8340
FORK 28" Suntour SF20-NEX DS 63
HEADSET Head set VP MH-309A, anod black, AL, D:1-1/8", conical cover
STEM KTM Line adjust, AL-KT3
HANDLEBAR KTM Line backs.20 640mm
GRIP KTM COMP ERGO Lock 131.6mm
ROTOR Shimano RT10 CL 160
DRAKE Shimano EF505 2-Piston
CHAINWHEEL Shimano TY501 48-38-28
CHAIN Shimano HG40

SPROCKET Shimano HG31-8 11-32
F. DERAILL. Shimano TY710 TS
R. DERAILL. Shimano Acra M360-8 S6SL
F HUB Shimano 36H DH3D37 36H CL QR
R HUB Shimano FH-TX505 36H CL QR
SPOKE RM 2.0 INOX, silver
RIM REMERX TOP DISC 32H 622x19
TIRES SCHWALBE CITIZEN K-Guard 42-622 700x40C
SADDLE SELLE ROYAL Rio
SEATPOST KTM Line 27.2/300

PEDAL Onroad Pedal VPE-857 EPB
MUDGUARD RPZ 28 46 black matt
CARRIER KTM TOUR 28" RACKTIME
KICKSTAND KTM CENTER 24-28" adjust
F LIGHTING B&M LUMOTEC Upp N LED 30Lux
R LIGHTING TRELOCK DUO FLAT
GUARD SKS CHAINBLADE
CATEGORY 2
SYSTEM WEIGHT 130 kg (permissible total weight)
WEIGHT 16,5 kg (without pedals)



black matt (cotto glossy)

- ✓ 020215106 LIFE SPACE H 46
- ✓ 020215111 LIFE SPACE H 51
- ✓ 020215116 LIFE SPACE H 56
- ✓ 020215120 LIFE SPACE H 60

black matt (cotto glossy)

- ✓ 020215206 LIFE SPACE D 46
- ✓ 020215211 LIFE SPACE D 51

black matt (cotto glossy)

- ✓ 020215503 LIFE SPACE E 43
- ✓ 020215506 LIFE SPACE E 46
- ✓ 020215511 LIFE SPACE E 51

black matt (orange glossy)

- ✓ 020216106 LIFE RIDE H 46
- ✓ 020216111 LIFE RIDE H 51
- ✓ 020216116 LIFE RIDE H 56
- ✓ 020216120 LIFE RIDE H 60

black matt (orange glossy)

- ✓ 020216206 LIFE RIDE D 46
- ✓ 020216211 LIFE RIDE D 51

black matt (orange glossy)

- ✓ 020216503 LIFE RIDE E 43
- ✓ 020216506 LIFE RIDE E 46
- ✓ 020216511 LIFE RIDE E 51

LIFE TIME

3x8 SHIMANO DEORE

3x8 SHIMANO ALTUS

LIFE JOY

ONROAD

ONROAD



FRAME 28" AL6061 Trekking-ONT8010
FORK 28" Suntour SF20-NEX P 63
HEADSET Head set VP MH-309A, anod black, AL, D:1-1/8", conical cover
STEM KTM Line adjust. AL-KT3
HANDLEBAR KTM Line backs.20 640mm
GRIP KTM COMP ERGO Lock 131.6mm
ROTOR V Shimano Alivio T4000
BRAKE Shimano TY501 48-38-28
CHAINWHEEL Shimano HG40
CHAIN Shimano HG31-8 11-32

SPROCKET Shimano TY710 TS
F. DERAILL. Shimano deore M591-8 SGSL
R. DERAILL. Shimano Altus ST-EF500 8
F HUB Shimano DHC30003 36H Nut
R HUB Shimano FH-TX500 36H QR
SPOKE RM 2.0 INOX, silver
RIM REMERX DRAGON 36H 622x19
TIRES SCHWALBE CITIZEN K-Guard 42-622 700x40C
SADDLE SELLE ROYAL Rio
SEATPOST KTM Line 27.2/300

PEDAL Onroad Pedal VPE-857 EPB
MUDGUARD RPZ 28 46 black
CARRIER KTM TOUR 28" RACKTIME
KICKSTAND KTM CENTER 24-28" adjust
F LIGHTING B&M LUMOTEC Upp N LED 30Lux
R LIGHTING TRELOCK DUO FLAT
GUARD SKS CHAINBLADE
CATEGORY ● 2
SYSTEM WEIGHT 130 kg (permissible total weight)
WEIGHT 16.4 kg (without pedals)

FRAME 28" AL6061 Trekking-ONT8010
FORK 28" Suntour SF14-M3010 P 50
HEADSET Head set VP MH-309A, anod black, AL, D:1-1/8", conical cover
STEM KTM Line AL-231
HANDLEBAR KTM Line backs.20 640mm
GRIP KTM Diamond Grip 130mm black ring
ROTOR V TEKTR0 837AL
BRAKE Shimano TY301 48-38-28
CHAINWHEEL Shimano HG40
CHAIN Shimano HG200-8 12-32

SPROCKET Shimano TY710 TS
F. DERAILL. Shimano Altus M310DL-8
R. DERAILL. Shimano Altus ST-EF5002 8
F HUB Shimano DHC30003 36H Nut
R HUB Shimano FH-TX500 36H QR
SPOKE RM 2.0 INOX, silver
RIM REMERX DRAGON 36H 622x19
TIRES SCHWALBE CITIZEN K-Guard 42-622 700x40C
SADDLE SELLE ROYAL Rio
SEATPOST KTM Line 27.2/300

PEDAL Onroad Pedal VPE-891 EPB
MUDGUARD RPZ 28 46 black matt
CARRIER KTM TOUR 28" RACKTIME
KICKSTAND KTM CENTER 24-28" adjust
F LIGHTING AXA COMPACTLINE LED 20Lux
R LIGHTING TRELOCK DUO FLAT
GUARD HERRMANS KS
CATEGORY ● 2
SYSTEM WEIGHT 130 kg (permissible total weight)
WEIGHT 15.9 kg (without pedals)



epicgrey (black)
 ✓ 020217106 LIFE TIME H 46
 ✓ 020217111 LIFE TIME H 51
 ✓ 020217116 LIFE TIME H 56
 ✓ 020217120 LIFE TIME H 60

epicgrey (black)
 ✓ 020217206 LIFE TIME D 46
 ✓ 020217211 LIFE TIME D 51

epicgrey (black)
 ✓ 020217306 LIFE TIME C 46
 ✓ 020217311 LIFE TIME C 51

epicgrey (black)
 ✓ 020217503 LIFE TIME E 43
 ✓ 020217506 LIFE TIME E 46
 ✓ 020217511 LIFE TIME E 51



silver matt (black)
 ✓ 020218106 LIFE JOY H 46
 ✓ 020218111 LIFE JOY H 51
 ✓ 020218116 LIFE JOY H 56
 ✓ 020218120 LIFE JOY H 60

silver matt (black)
 ✓ 020218206 LIFE JOY D 46
 ✓ 020218211 LIFE JOY D 51
 ✓ 020218216 LIFE JOY D 56

silver matt (black)
 ✓ 020218306 LIFE JOY C 46
 ✓ 020218311 LIFE JOY C 51

silver matt (black)
 ✓ 020218503 LIFE JOY E 43
 ✓ 020218506 LIFE JOY E 46
 ✓ 020218511 LIFE JOY E 51
 ✓ 020218516 LIFE JOY E 56



moon (grey+indianred)
 ✓ 020217236 LIFE TIME D 46
 ✓ 020217241 LIFE TIME D 51

moon (grey+indianred)
 ✓ 020217336 LIFE TIME C 46
 ✓ 020217341 LIFE TIME C 51

moon (grey+indianred)
 ✓ 020217533 LIFE TIME E 43
 ✓ 020217536 LIFE TIME E 46
 ✓ 020217541 LIFE TIME E 51



steelgrey matt (black+orange)
 ✓ 020218136 LIFE JOY H 46
 ✓ 020218141 LIFE JOY H 51
 ✓ 020218146 LIFE JOY H 56
 ✓ 020218150 LIFE JOY H 60

aqua (eveblue+white)
 ✓ 020218266 LIFE JOY D 46
 ✓ 020218271 LIFE JOY D 51
 ✓ 020218276 LIFE JOY D 56

aqua (eveblue+white)
 ✓ 020218366 LIFE TIME C 46
 ✓ 020218371 LIFE TIME C 51

aqua (eveblue+white)
 ✓ 020218563 LIFE JOY E 43
 ✓ 020218566 LIFE JOY E 46
 ✓ 020218571 LIFE JOY E 51
 ✓ 020218576 LIFE JOY E 56

KENT / CHESTER OXFORD



KENT
NEXUS 1*8

148-151



CHESTER
NEXUS 1*7

152



OXFORD
ALTUS 1*9

153

CITY



CITY LINE 28.7
NEXUS 1*7

156



CITY LINE 26.7
NEXUS 1*7

157



CITY FUN 28.3
NEXUS 1*3

158



CITY FUN 26.3
NEXUS 1*3

159

KENT

INTEGRATED
KICKSTAND MOUNT



iFM INTEGRATED
FLATMOUNT

BELT
DRIVE

Bereit für das urbane Abenteuer.

Mehr als die Hälfte der Weltbevölkerung hat sich in Städten angesiedelt. Schon seit der Antike gilt die Stadt als Platz der Begegnung und Auseinandersetzung. Die zunehmende Landflucht bringt auch einiges an Konfliktpotential mit sich, vor allem

in der Mobilität. Die Gründe dafür, dass viele Städter aufs Rad und in die Pedale steigen und urbane Mobilität inzwischen oftmals mit Fahrradmobilität gleichgesetzt wird, sind vielfältig. Die auf urbane Mobilität ausgerichteten Urban-Bikes

beweisen nicht nur absolute Tauglichkeit bei allen Tageszeiten, Witterungsverhältnissen und Bodenbeschaffenheiten. Sie krönen ihre Funktionalität auch mit puristisch-elegantem Design, das den Nerv der Pendler trifft. Das KENT 28.8 BELT ist KTM's Vorzeigemodell der Urban-Cityräder. Wartungsfreier Riemenantrieb, stabile Ausstattung und edles Design samt Vollausstattung. Neben dem KENT warten noch viele weitere Modelle. Im Sortiment der KTM Urban-Citybikes wird jeder seinen Liebling finden.

Ready for urban adventure.

More than half of the world's population has settled down in cities, but as the cities population grows, so does the chaos on the city roads. To battle this more cyclists are taking to the road to skip the traffic jams and make the cities theirs! The bicycle

has become a status symbol for the urban citizen. Urban Bikes are not only well known for their suitability and reliability in all conditions, they also crown their functionality with a sleek and elegant design that catches

the eye of commuters. The KENT 28.8 BELT is KTM's flagship model of urban city bikes. Maintenance-free belt drive, stable equipment and a cool design make it very special. In addition to the KENT many more models are available such as the Chester and Oxford. Everyone will find their favorite in the range of KTM Urban City Bikes.

YOUR CITY.
YOUR BIKE.



1x8 SHIMANO NEXUS

KENT



FRAME	28" AL6061 Urban-ON T9630	SPROCKET	CARBON DRIVE 22	PEDAL	Onroad Pedal VPE-857 EPB
FORK	28" RIGID alloy	SHIFTER	Shimano NEXUS-8	MUDGUARD	SKS PET 28 A 46 R black matt
HEADSET	RITCHEY LOGIC ZERO PRESS FIT, 1-1/8", H.9.4mm	F HUB	Shimano 36H DH3D37 36H CL QR	CARRIER	KTM LIGHT 28" RACKTIME
STEM	KTM Line 7"	R HUB	Shimano 36H NEXUS-8 DISC	KICKSTAND	KTM CENTER 24-28" adjust
HANDLEBAR	BLACK NOIRETTE rizer17 backs.15 630mm	SPOKE	RM 2.0 INOX, silver	F LIGHTING	TRELOCK BIKE-i VEO LS 233 LED
GRIP	VELO VL6-649-1/AD2S GEL 134.5mm, 92mm	RIM	REMERX TOP DISC 32H 622x19	R LIGHTING	TRELOCK DUO FLAT
ROTOR	Shimano RT10 CL 160	TIRES	SCHWALBE CITIZEN K-Guard 42-622 700x40C	CATEGORY	2
DRAKE	Shimano MT200 2-Piston	SADDLE	KTM Line Urban	SYSTEM WEIGHT	130 kg (permissible total weight)
CHAINWHEEL	CARBON DRIVE 46	SEATPOST	Black Line 27.2/300	WEIGHT	14.6 kg (without pedals)
CHAIN	Belt CARBON DRIVE CDN8118				



- epicgrey matt (grey glossy)
- 020220111 KENT H 51
- 020220116 KENT H 56
- 020220120 KENT H 60

- epicgrey matt (grey glossy)
- 020220206 KENT D 46
- 020220211 KENT D 51



CHESTER

1x7 SHIMANO NEXUS

1x9 SHIMANO ALTUS

OXFORD



FRAME 28" AL6061 Urban-ON T8640
FORK 28" RIGID alloy
HEADSET RITCHEY LOGIC ZERO PRESS FIT, 1-1/8", H:9.4mm
STEM KTM Line 7"
HANDLEBAR BLACK NOIRETTE rizer17 backs.15 630mm
GRIP VELO VL6-649-1/AD2S GEL 134,5mm, 92mm
ROTOR Shimano RT10 CL 160
BRAKE Shimano MT200 2-Piston
CHAINWHEEL SUNTOUR CW16 42
CHAIN KMC Z1 1/2"x3/32"

SPROCKET Shimano 19
SHIFTER Shimano NEXUS-7
F HUB Shimano 36H DH3D37 36H CL QR
R HUB Shimano 36H NEXUS-7 DISC
SPOKE RM 2.0 INOX, silver
RIM REMERX TOP DISC 32H 622x19
TIRES SCHWALBE CITIZEN K-Guard 42-622 700x40C
SADDLE KTM Line Urban
SEATPOST Black Line 27.2/300

PEDAL Onroad Pedal VPE-857 EPB
MUDGUARD SKS PET 28 A 46 R black matt
CARRIER KTM LIGHT 28" RACKTIME
KICKSTAND KTM CENTER 24-28" adjust
F LIGHTING TRELOCK BIKE-i VEO LS 233 LED
R LIGHTING TRELOCK DUO FLAT
CATEGORY ● 2
SYSTEM WEIGHT 130 kg (permissible total weight)
WEIGHT 14,5 kg (without pedals)

FRAME 28" AL6061 Urban-ON T8620
FORK 28" RIGID alloy
HEADSET RITCHEY LOGIC ZERO PRESS FIT, 1-1/8", H:9.4mm
STEM KTM Line 7"
HANDLEBAR BLACK NOIRETTE rizer17 backs.15 630mm
GRIP KTM Lock, Gel 133mm
ROTOR Shimano RT10 CL 160
BRAKE Shimano MT200 2-Piston
CHAINWHEEL LASCO FR650 38

CHAIN Shimano HG53
SPROCKET Shimano HG201-9 11-32
R. DERAILL. Shimano Altus M2000-9 SGS shadow
SHIFTER Shimano Altus SL-M201 9
F HUB Shimano 36H DH3D37 36H CL QR
R HUB Shimano FH-TX505 36H CL QR
SPOKE RM 2.0 INOX, silver
RIM REMERX TOP DISC 32H 622x19
TIRES SCHWALBE CITIZEN K-Guard 42-622 700x40C
SADDLE KTM Line Urban

SEATPOST Black Line 27.2/300
PEDAL Onroad Pedal VPE-857 EPB
MUDGUARD SKS PET 28 A 46 R black matt
CARRIER KTM LIGHT 28" RACKTIME
KICKSTAND KTM CENTER 24-28" adjust
F LIGHTING TRELOCK BIKE-i VEO LS 233 LED
R LIGHTING TRELOCK DUO FLAT
CATEGORY ● 2
SYSTEM WEIGHT 130 kg (permissible total weight)
WEIGHT 13,8 kg (without pedals)



■ black matt (black metallic glossy)

- ✓ 020221111 CHESTER H 51
- ✓ 020221116 CHESTER H 56
- ✓ 020221120 CHESTER H 60

■ black matt (black metallic glossy)

- ✓ 020221206 CHESTER D 46
- ✓ 020221211 CHESTER D 51



■ silver matt (white glossy)

- ✓ 020222111 KENT H 51
- ✓ 020222116 KENT H 56
- ✓ 020222120 KENT H 60

■ silver matt (white glossy)

- ✓ 020222206 KENT D 46
- ✓ 020222211 KENT D 51

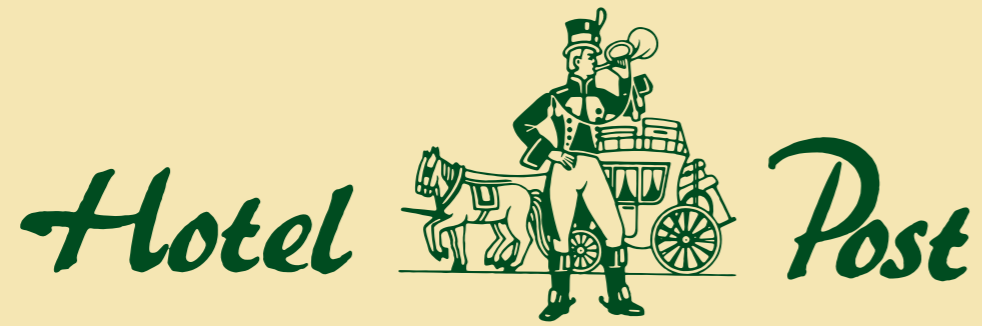

Weißenbach am Attersee



Sommerfrische am Attersee

Radurlaub im Salzkammergut

www.hotelpost-attersee.at

Sport, Kultur und Erholung



E-Bike, MTB & Rennrad Touren

Rund um den Attersee finden sich für alle sportbegeisterten E-Bike, Mountainbike- & Rennrad Fans zahlreiche Touren. Das umliegende Höllengebirge bietet für Mountainbiker die idealen Voraussetzungen. Von knackigen Trails bis hin zu gemütlichen Forststraßen - im Salzkammergut ist für jeden etwas dabei. Im Umkreis von 20 - 45 km erreichen Sie Bad Ischl und die schönsten Seen des Salzkammerguts. Wolfgangsee, Mondsee, Fuschlsee und Hallstättersee befinden sich praktisch vor Ihrer Haustüre.

Seenrunde Salzkammergut

Das Hotel Post liegt in einer der idyllischsten Regionen Österreichs. Herrliche Landschaften lassen sich auf dem Rad erkunden. Ein wunderschöner Tagesausflug rund um den Schafberg beginnt direkt am Hotel in Richtung Bad Ischl. Von der Kaiserstadt geht es in Richtung Wolfgangsee, wo Sie einen wunderbaren Blick auf den Schafberg genießen. Von St. Gilgen aus überwinden Sie den Scharfling, gelangen direkt an den Mondsee und fahren auf sanftem Gelände zurück zum Hotel.

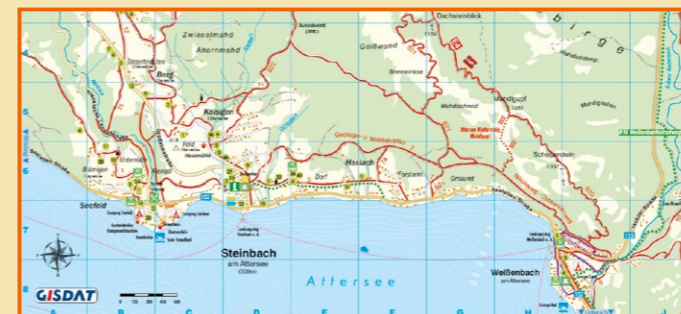

KTM Fahrräder und eBikes für Hotelgäste

Für seine Gäste bietet das Hotel Post ein ganz aussergewöhnliches Zuckerl. Sie können kostenlos KTM eBikes und normale Fahrräder benutzen und damit die Gegend erkunden. Die herrlichen Salzkammergut Radwege warten nur auf Sie.

Hotel Post am Attersee GmbH
Ischler Straße 1
A-4854 Weißenbach / Attersee
Tel.: +43 (0) 7663 / 8141
Fax.: +43 (0) 7663 / 8141-45
office@hotelpost-attersee.at

CITY

LINE 28.7

⚙️ 1×7 SHIMANO NEXUS
COASTERBRAKE



FRAME 28" AL6061 CITY LINE C7690-L
FORK 28" Suntour SF13-CR8-V
HEADSET Head set VP MH-305C, STD:1-1/8", H:20mm
STEM KTM Line adjust. AL-KT3
HANDLEBAR KTM Line rizer70 backs.50 600mm
GRIP VELO VL6-649-1/AD2S GEL 134,5mm, 92mm
DRAKE V TEKTR0 CL330 / 855AL
CHAINWHEEL SUNTOUR CW17 38
CHAIN KMC Z1 1/2"x3/32"
SPROCKET Shimano 19

SHIFTER Shimano NEXUS-7
F HUB Shimano DHC30003 36H Nut
R HUB Shimano 36H NEXUS-7
SPOKE RM 2.0 INOX, silver
RIM REMERX DRAGON 36H 622x19
TIRES SCHWALBE CITIZEN K-Guard 42-622
700x40C
SADDLE SELLE ROYAL Rio City
SEATPOST KTM Line suspension 27.2/300
PEDAL Onroad Pedal VPE-857 EPB

MUDGUARD RPZ 28 46 black matt
CARRIER KTM 28" RACKTIME
KICKSTAND KTM CENTER 24-28" adjust
F LIGHTING TRELOCK BASIC LS 102 LED
R LIGHTING TRELOCK DUO FLAT
GUARD HERRMANS SLYDE
CATEGORY ● 2
SYSTEM WEIGHT 117 kg (permissible total weight)
WEIGHT 17 kg (without pedals)



■ black matt (grey+silver)

- ✓ 020230503 CITY LINE 28 D-W 43
- ✓ 020230506 CITY LINE 28 D-W 46
- ✓ 020230511 CITY LINE 28 D-W 51
- ✓ 020230516 CITY LINE 28 D-W 56



■ bordeaux matt (grey+black)

- ✓ 020230533 CITY LINE 28 D-W 43
- ✓ 020230536 CITY LINE 28 D-W 46
- ✓ 020230541 CITY LINE 28 D-W 51
- ✓ 020230546 CITY LINE 28 D-W 56

CITY

LINE 26.7

⚙️ 1×7 SHIMANO NEXUS
COASTERBRAKE



FRAME 26" AL6061 CITY LINE C7010
FORK 26" Suntour SF13-CR8-V
HEADSET Head set VP MH-305C, STD:1-1/8", H:20mm
STEM KTM Line adjust. AL-KT3
HANDLEBAR KTM Line rizer70 backs.50 600mm
GRIP VELO VL6-649-1/AD2S GEL 134,5mm, 92mm
DRAKE V TEKTR0 CL330 / 855AL
CHAINWHEEL SUNTOUR CW17 38
CHAIN KMC Z1 1/2"x3/32"
SPROCKET Shimano 19

SHIFTER Shimano NEXUS-7
F HUB Shimano DHC30003 36H Nut
R HUB Shimano 36H NEXUS-7
SPOKE RM 2.0 INOX, silver
RIM REMERX DRAGON 36H 559x19
TIRES SCHWALBE CITIZEN K-Guard 47-559
26x1.75
SADDLE SELLE ROYAL Rio City
SEATPOST KTM Line suspension 27.2/300
PEDAL Onroad Pedal VPE-857 EPB

MUDGUARD RPZ 26 55 black matt
CARRIER KTM 26" RACKTIME
KICKSTAND KTM CENTER 24-28" adjust
F LIGHTING TRELOCK BASIC LS 102 LED
R LIGHTING TRELOCK DUO FLAT
GUARD HERRMANS SLYDE
CATEGORY ● 2
SYSTEM WEIGHT 117 kg (permissible total weight)
WEIGHT 16.7 kg (without pedals)



■ black matt (grey+silver)

- ✓ 020231503 CITY LINE 26 D-W 43

CITY

FUN 28.3

⚙️ 1×3 SHIMANO NEXUS
COASTERBRAKE



FRAME	28" AL6061 CITY FUN C7070
FORK	28" RIGID
HEADSET	Head set VP MH-305C, STD:1-1/8", H:20mm
STEM	KTM Line adjust. AL-828
HANDLEBAR	KTM Line rizer70 backs.50 580mm
GRIP	VELO VL6-709-1/AD3 130mm, 92mm
DRAKE	V TEKTR0 CL330 / 855AL
CHAINWHEEL	SUNTOUR CW17 38
CHAIN	KMC Z1 1/2"x3/32"
SPROCKET	Shimano 19

SHIFTER	Shimano NEXUS-3
F HUB	Shimano DHC30003 36H Nut
R HUB	Shimano 36H NEXUS-3
SPOKE	RM 2.0 INOX, silver
RIM	REMERX DRAGON 36H 622x19
TIRES	IMPAC STREETPAC TwinSkin 42-622 700x40C
SADDLE	SELLE ROYAL Rio City
SEATPOST	KTM Line 27.2/300
PEDAL	Onroad Pedal VPE-857 EPB

MUDGUARD	RPZ 28 46 black matt
CARRIER	KTM 28" RACKTIME
KICKSTAND	KTM CENTER 24-28" adjust
F LIGHTING	TRELOCK BASIC LS 102 LED
R LIGHTING	TRELOCK DUO FLAT
GUARD	HERRMANS SLYDE
CATEGORY	● 2
SYSTEM WEIGHT	115 kg (permissible total weight)
WEIGHT	15 kg (without pedals)



■ black matt (grey+silver)

- ✓ 020232533 CITY FUN 28 D-W 43
- ✓ 020232536 CITY FUN 28 D-W 46
- ✓ 020232541 CITY FUN 28 D-W 51



■ bordeaux matt (grey+black)

- ✓ 020232503 CITY FUN 28 D-W 43
- ✓ 020232506 CITY FUN 28 D-W 46
- ✓ 020232511 CITY FUN 28 D-W 51

CITY

FUN 26.3

⚙️ 1×3 SHIMANO NEXUS
COASTERBRAKE



FRAME	26" AL6061 CITY FUN C7020
FORK	26" RIGID steel
HEADSET	Head set VP MH-305C, STD:1-1/8", H:20mm
STEM	TRELOCK BASIC LS 102 LED
HANDLEBAR	KTM Line rizer70 backs.50 580mm
GRIP	VELO VL6-709-1/AD3 130mm, 92mm
DRAKE	V TEKTR0 CL330 / 855AL
CHAINWHEEL	SUNTOUR CW17 38
CHAIN	KMC Z1 1/2"x3/32"
SPROCKET	Shimano 19

SHIFTER	Shimano NEXUS-3
F HUB	Shimano DHC30003 36H Nut
R HUB	Shimano 36H NEXUS-3
SPOKE	RM 2.0 INOX, silver
RIM	REMERX DRAGON 36H 559x19
TIRES	IMPAC STREETPAC TwinSkin 47-559 26x1.75
SADDLE	SELLE ROYAL Rio City
SEATPOST	KTM Line 27.2/300
PEDAL	Onroad Pedal VPE-857 EPB

MUDGUARD	RPZ 26 55 black matt
CARRIER	KTM 26" RACKTIME
KICKSTAND	KTM CENTER 24-28" adjust
F LIGHTING	TRELOCK BASIC LS 102 LED
R LIGHTING	TRELOCK DUO FLAT
GUARD	HERRMANS SLYDE
CATEGORY	● 2
SYSTEM WEIGHT	115 kg (permissible total weight)
WEIGHT	15 kg (without pedals)



■ bordeaux matt (grey+black)

- ✓ 020233503 CITY FUN 26 D-W 43

WILD



WILD SPEED 26.24 DISC
ALTUS 3x8 162



WILD SPEED 26.24
ALTUS 3x8 163



WILD SPEED 24.24 DISC
ALTUS 3x8 164



WILD SPEED 24.24
ALTUS 3x8 165



WILD SPEED 24.9 DISC
ALTUS 1x9 166



WILD SPEED 20.21
ALTUS 3x7 167



WILD CROSS 24.18
TV21 2x9 168



WILD CROSS STREET 24.18
TV21 2x9 169



WILD CROSS 20.12
TV21 2x6 170



WILD BEE 24.18
TV21 2x9 171



WILD BEE 20.12
TV21 2x6 172



WILD ONE 24.18
TV21 2x9 173



WILD ONE 20.6
TV21 1x6 174

COUNTRY STAR/WILDCAT



COUNTRY STAR 26.21
ALTUS 3x7 175



WILDCAT 24.18
TV21 2x9 176



WILDCAT 20.6
TV21 1x6 177

KID



KID 12.1 ORANGE/BLACK 178



KID 12.1 WHITE/PINK 178



KID 16.1 ONETUBE 179



KID 16.1 MTB 179

WILD

SPEED 26.24 DISC

3x8 SHIMANO ALTUS

3x8 SHIMANO ALTUS

WILD

SPEED 26.24



FRAME 26" AL6061 KID WILD SPEED DISC K7660, 340mm
FORK 26" Suntour SF18-XCE28 DS 80
HEADSET RITCHEY LOGIC ZERO PRESS FIT, 1-1/8", H:9.4mm
STEM KTM Line 4bolt E:60mm, R:15
HANDLEBAR KTM Line rizer20 600mm
GRIP KTM Dimond Grip 130mm black ring
ROTOR Shimano RT10 CL 160
DRAKE Shimano TX805 2-Piston
CHAINWHEEL Shimano TY301 42-34-24 150

CHAIN Shimano HG40
SPROCKET Shimano HG31-8 11-34
F. DERAILL. Shimano TY700 TS
R. DERAILL. Shimano Altus M310DL-8
SHIFTER Shimano Tourney ST-TX800 8
F HUB Shimano HB-TX505 32H CL QR
R HUB Shimano FH-TX505 32H CL QR
SPOKE RM 2.0 INOX, silver
RIM REMERX TOP DISC 32H 622x19

TIRES SCHWALBE BLACK JACK K-Guard
 54-559 26x2.10
SADDLE KTM Line MTB
SEATPOST KTM Line 27.2/300
PEDAL JR Pedal VPE-229
CATEGORY ● 2
SYSTEM WEIGHT 130 kg (permissible total weight)
WEIGHT 14,5 kg (without pedals)



FRAME 26" AL6061 KID WILD SPEED K7610, 340mm
FORK 26" Suntour SF18-XCE28 80 P
HEADSET RITCHEY LOGIC ZERO PRESS FIT,
 1-1/8", H:9.4mm
STEM KTM Line 4bolt E:60mm, R:15
HANDLEBAR KTM Line rizer20 600mm
GRIP KTM Dimond Grip 130mm black ring
DRAKE V TEKTR0 837AL
CHAINWHEEL Shimano TY301 42-34-24 150

CHAIN Shimano HG40
SPROCKET Shimano HG31-8 11-34
F. DERAILL. Shimano TY700 TS
R. DERAILL. Shimano Altus M310DL-8
SHIFTER Shimano Tourney ST-TX800 8
F HUB Shimano HB-TX500 32H QR
R HUB Shimano FH-TX500 32H QR
SPOKE RM 2.0 INOX, silver
RIM REMERX DRAGON 32H 559x19

TIRES SCHWALBE BLACK JACK K-Guard
 50-559 26x2.00
SADDLE KTM Line MTB
SEATPOST KTM Line 27.2/300
PEDAL JR Pedal VPE-229
CATEGORY ● 2
SYSTEM WEIGHT 130 kg (permissible total weight)
WEIGHT 13,9 kg (without pedals)



black matt (orange)
 020240100 WILD SPEED DISC 26



epicgrey matt (black+orange)
 020241100 WILD SPEED 26

WILD

SPEED 24.24 DISC

⚙️ 3x8 SHIMANO ALTUS

⚙️ 3x8 SHIMANO ALTUS

WILD

SPEED 24.24

KIDS



FRAME 24" AL6061 KID WILD SPEED DISC K7460, 310mm
FORK 24" Suntour SF16-XCT-JR-LDS 80
HEADSET RITCHEY LOGIC ZERO PRESS FIT, 1-1/8", H:9.4mm
STEM KTM Line 4bolt E:60mm, R:15
HANDLEBAR KTM Line rizer20 560mm
GRIP VELO VLG-184-7AD2, L:110mm
ROTOR Shimano RT10 CL 160
DRAKE Shimano TX805 2-Piston
CHAINWHEEL SUNTOUR CW16 42-34-24 152

CHAIN Shimano HG71
SPROCKET Shimano HG31-8 11-34
F. DERAILL. Shimano TY700 TS
R. DERAILL. Shimano Altus M310DL-8
SHIFTER Shimano Tourney ST-TX800 8
F HUB Shimano HB-TX505 32H CL QR
R HUB Shimano FH-TX505 32H CL QR
SPOKE RM 2.0 INOX, silver
RIM REMERX TOP DISC 32H 622x19

TIRES SCHWALBE BLACK JACK K-Guard 47-507 24x1.90
SADDLE KTM Line MTB JR SPEED
SEATPOST KTM Line 27.2/250
PEDAL JR Pedal VPE-229
CATEGORY ● 2
SYSTEM WEIGHT 63 kg (permissible total weight)
WEIGHT 12,8 kg (without pedals)

FRAME 24" AL6061 KID WILD SPEED K7410, 310mm
FORK 24" Suntour SF12-XCT-JR P
HEADSET RITCHEY LOGIC ZERO PRESS FIT, 1-1/8", H:9.4mm
STEM KTM Line 4bolt E:60mm, R:15
HANDLEBAR KTM Line rizer20 560mm
GRIP VELO VLG-184-5AD2, L:92mm
DRAKE V TEKTR0 855AL
CHAINWHEEL SUNTOUR CW16 42-34-24 152

CHAIN Shimano HG71
SPROCKET Shimano HG31-8 11-34
F. DERAILL. Shimano TY700 TS
R. DERAILL. Shimano Altus M310DL-8
SHIFTER Shimano Tourney ST-TX800 8
F HUB Shimano HB-TX500 32H QR
R HUB Shimano FH-TX500 32H QR
SPOKE RM 2.0 INOX, silver
RIM REMERX DRAGON 32H 607x19

TIRES SCHWALBE BLACK JACK K-Guard 47-507 24x1.90
SADDLE KTM Line MTB JR SPEED
SEATPOST KTM Line 27.2/250
PEDAL JR Pedal VPE-229
CATEGORY ● 2
SYSTEM WEIGHT 62 kg (permissible total weight)
WEIGHT 12,2 kg (without pedals)



■ black matt (orange)
 020242100 WILD SPEED DISC 24



■ epicgrey matt (black+orange)
 020243100 WILD SPEED 24

WILD

SPEED 24.9 DISC

⚙️ 1×9 SHIMANO ALTUS

⚙️ 3×7 SHIMANO ALTUS

WILD

SPEED 20.21



FRAME 24" AL6061 KID WILD SPEED LIGHT DISC K7461, 310mm
FORK 24" RIGID alloy
HEADSET RITCHEY LOGIC ZERO PRESS FIT, 1-1/8", H:9.4mm
STEM KTM Line 4bolt E:60mm, R:15
HANDLEBAR KTM Line rizer20 560mm
GRIP VELO VLG-184-5AD2, L:92mm
ROTOR Shimano RT10 CL 160
DRAKE TEKTR0 RX1.0 / Shimano TX805 2-Piston

CHAINWHEEL LASCO FM2536 36 145
CHAIN Shimano HG53
SPROCKET Shimano HG201-9 11-32
R. DERAILL. Shimano Altus M2000-9 SGS shadow
SHIFTER Shimano Acera SL-M3000 9
F HUB Shimano HB-TX505 32H CL QR
R HUB Shimano FH-TX505 32H CL QR
SPOKE RM 2.0 INOX, silver
RIM REMERX TOP DISC 32H 622x19

TIRES SCHWALBE BLACK JACK K-Guard 47-507 24x1.90
SADDLE KTM Line MTB JR SPEED
SEATPOST KTM Line 27.2/250
PEDAL JR Pedal VPE-229
CATEGORY ● 2
SYSTEM WEIGHT 61 kg (permissible total weight)
WEIGHT 10,7 kg (without pedals)



FRAME 20" AL6061 KID WILD SPEED K7010, 270mm
FORK 20" Suntour SF13 XCT JR P
HEADSET RITCHEY LOGIC ZERO PRESS FIT, 1-1/8", H:9.4mm
STEM KTM Line 4bolt E:60mm, R:15
HANDLEBAR KTM Line rizer20 520mm
GRIP VELO VLG-184-6AD2, L:76mm
DRAKE V TEKTR0 TS325A / J310
CHAINWHEEL LASCO CF0143 42-32-22 127

CHAIN Shimano HG71
SPROCKET Shimano HG200-7 12-28
F. DERAILL. Shimano TY700 TS
R. DERAILL. Shimano Altus M310DL-7
SHIFTER Shimano SL-RS45 7
F HUB Shimano HB-TX500 32H QR
R HUB Shimano FH-TX500 32H QR
SPOKE RM 2.0 INOX, silver
RIM REMERX DRAGON 32H 406x19

TIRES SCHWALBE BLACK JACK K-Guard 47-406 20x1.90
SADDLE KTM Line MTB JR SPEED
SEATPOST KTM Line 27.2/250
PEDAL JR Pedal VPE-229
CATEGORY ● 2
SYSTEM WEIGHT 61 kg (permissible total weight)
WEIGHT 10,8 kg (without pedals)



■ black matt (orange)
 020244100 WILD SPEED 24.9



■ epicgrey matt (black+orange)
 020245100 WILD SPEED 20

WILD

CROSS 24.18

2x9 SHIMANO TV21

2x9 SHIMANO TV21

WILD

CROSS STREET 24.18



FRAME 24" AL6061 KID WILD CROSS STREET K7450, 310mm
FORK 24" Suntour SF15-M3010 P
HEADSET Ahead set, semi-integr., water proof, black
STEM KTM Line E: 60mm, R: 15
HANDLEBAR KTM Line rizer 20 560mm
GRIP VELO VLG-184-6AD2, L: 76mm
BRAKE V TEKTRO TS325 / 837AL
CHAINWHEEL LASCO CF5843 42-32-22 140

CHAIN KMC Z7 1/2"x3/32"
SPROCKET Shimano FTZ500-6 14-28
F. DERAILL. Shimano TV500 TS
R. DERAILL. Shimano TV21-6
SHIFTER Shimano SL-RS36 6
F HUB QUANDO 36H KT-A16F Nut
R HUB QUANDO 36H KT-A11R Nut
SPOKE RM 2.0 INOX, silver
RIM REMERX DRAGON 36H 507x19

TIRES RUBENA V75 SCYLLA 50-507 24x1.90
SADDLE KTM Line MTB JR
SEATPOST KTM Line 27.2/250
PEDAL MTB Pedal VP-223 JR
KICKSTAND KTM CENTER 24-28" adjust
CATEGORY ● 2
SYSTEM WEIGHT 63 kg (permissible total weight)
WEIGHT 13.2 kg (without pedals)

FRAME 24" AL6061 KID WILD CROSS STREET K7450, 310mm
FORK 24" Suntour SF15-M3010 P
HEADSET Ahead set, semi-integr., water proof, black
STEM KTM Line E: 60mm, R: 15
HANDLEBAR KTM Line rizer 20 560mm
GRIP VELO VLG-184-6AD2, L: 76mm
BRAKE V TEKTRO TS325 / 837AL
CHAINWHEEL LASCO CF5843 42-32-22 140
CHAIN KMC Z7 1/2"x3/32"

SPROCKET Shimano FTZ500-6 14-28
F. DERAILL. Shimano TV500 TS
R. DERAILL. Shimano TV21-6
SHIFTER Shimano SL-RS36 6
F HUB Shimano DHC30003 36H Nut
R HUB QUANDO 36H KT-A11R Nut
SPOKE RM 2.0 INOX, silver
RIM REMERX DRAGON 36H 507x19
TIRES RUBENA V75 SCYLLA 50-507 24x1.90
SADDLE KTM Line MTB JR

SEATPOST KTM Line 27.2/250
PEDAL MTB Pedal VP-223 JR
MUDGUARD SKS VELO 24 55 JUNIOR
KICKSTAND KTM CENTER 24-28" adjust
F LIGHTING AXA PICO15 LED 15Lux
R LIGHTING SPANINGA PIXEO
CATEGORY ● 2
SYSTEM WEIGHT 64 kg (permissible total weight)
WEIGHT 14kg (without pedals)



red (white+blue)
 020246100 WILD CROSS 24

croc matt (red+black)
 020246130 WILD CROSS 24



croc matt (red+black)
 020247100 WILD CROSS STREET 24

WILD

CROSS 20.12

2x6 SHIMANO TV21

2x9 SHIMANO TV21

WILD

BEE 24.18

KIDS



FRAME 20" AL6061 KID WILD CROSS K7020, 290mm
FORK 20" Suntour SF14-M3010-P
HEADSET Ahead set, semi-integr., water proof, black
STEM KTM Line E: 60mm, R: 15
HANDLEBAR KTM Line rizer 20 520mm
GRIP VELO VLG-184-6AD2, L: 76mm
BRAKE V TEKTRO TS325 / 837AL
CHAINWHEEL LASCO CF0111 42-34 127

CHAIN KMC Z7 1/2"x3/32"
SPROCKET Shimano FTZ500-6 14-28
F. DERAILL. Shimano TZ500 DS
R. DERAILL. Shimano TV21-6
SHIFTER Shimano SL-RS36 6
F HUB QUANDO 28H KT-A16F Nut
R HUB FORMULA 28H FM-31R Nut
SPOKE RM 2.0 INOX, silver
RIM REMERX DRAGON 28H 406x19

TIRES RUBENA V75 SCYLLA 50-406 20x1.90
SADDLE KTM Line MTB JR
SEATPOST KTM Line 27.2/250
PEDAL MTB Pedal VP-210 JR
KICKSTAND KTM CENTER 16-20" adjust
CATEGORY ● 2
SYSTEM WEIGHT 62 kg (permissible total weight)
WEIGHT 11,5 kg (without pedals)



FRAME 24" AL6061 KID WILD BEE/BEE STREET K7411, 310mm
FORK 24" Suntour SF15-M3010 P
HEADSET Ahead set, semi-integr., water proof, black
STEM KTM Line E: 60mm, R: 15
HANDLEBAR KTM Line rizer 20 560mm
GRIP VELO VLG-184-6AD2, L: 76mm
BRAKE V TEKTRO TS325 / 837AL
CHAINWHEEL LASCO CF5843 42-32-22 140

CHAIN KMC Z7 1/2"x3/32"
SPROCKET Shimano FTZ500-6 14-28
F. DERAILL. Shimano TV500 TS
R. DERAILL. Shimano TV21-6
SHIFTER Shimano SL-RS36 6
F HUB QUANDO 36H KT-A16F Nut
R HUB QUANDO 36H KT-A11R Nut
SPOKE RM 2.0 INOX, silver
RIM REMERX DRAGON 36H 507x19

TIRES RUBENA V75 SCYLLA 50-507 24x1.90
SADDLE KTM Line MTB JR
SEATPOST KTM Line 27.2/250
PEDAL MTB Pedal VP-223 JR
KICKSTAND KTM CENTER 24-28" adjust
CATEGORY ● 2
SYSTEM WEIGHT 63 kg (permissible total weight)
WEIGHT 13,2kg (without pedals)



red (white+blue)
 020248100 WILD CROSS 20



darkblue matt (aqua)
 020249100 WILD BEE 24

WILD

BEE 20.12

KIDS

2x9 SHIMANO TV21



FRAME 20" AL6061 KID WILD CROSS K7020, 290mm
FORK 20" Suntour SF14-M3010-P
HEADSET Ahead set, semi-integr., water proof, black
STEM KTM Line E: 60mm, R: 15
HANDLEBAR KTM Line rizer 20 520mm
GRIP VELO VLG-184-6AD2, L: 76mm
BRAKE V TEKTRO TS325 / 837AL
CHAINWHEEL LASCO CF0111 42-34 127

CHAIN KMC Z7 1/2"x3/32"
SPROCKET Shimano FTZ500-6 14-28
F. DERAILL. Shimano TY500 TS
R. DERAILL. Shimano TY21-6
SHIFTER Shimano SL-RS36 6
F HUB QUANDO 28H KT-A16F Nut
R HUB FORMULA 28H FM-31R Nut
SPOKE RM 2.0 INOX, silver
RIM REMERX DRAGON 28H 406x19

TIRES RUBENA V75 SCYLLA 50-406 20x1.90
SADDLE KTM Line MTB JR
SEATPOST KTM Line 27.2/250
PEDAL MTB Pedal VP-210 JR
KICKSTAND KTM CENTER 16-20" adjust
CATEGORY ● 2
SYSTEM WEIGHT 62 kg (permissible total weight)
WEIGHT 11,5kg (without pedals)



white (rose + purple)
 020250100 WILD BEE 20

2x9 SHIMANO TV21



FRAME 24" AL6061 KID WILD ONE K7430, 310mm
FORK 24" Suntour SF15-M3010 P
HEADSET Ahead set, semi-integr., water proof, black
STEM E60mm, R: 15
HANDLEBAR KTM Line rizer 20 560mm
GRIP VELO VLG-184-6AD2, L: 76mm
BRAKE V TEKTRO TS325A / 855AL
CHAINWHEEL LASCO CF5843 42-32-22 140
CHAIN KMC Z7 1/2"x3/32"
SPROCKET Shimano FTZ500-6 14-28

F. DERAILL. Shimano TY500 TS
R. DERAILL. Shimano TY21-6
SHIFTER Shimano SL-RS36 6
F HUB Shimano DHG30003 28H Nut
R HUB QUANDO 28H KT-A11R Nut
SPOKE RM 2.0 INOX, silver
RIM REMERX DRAGON 28H 507x19
TIRES RUBENA V41 WALRUS 47-507 24x1.75x2
SADDLE KTM Line CITY JR
SEATPOST KTM Line 27.2/250

WILD

ONE 24.18

KIDS



black matt (orange)
 020251100 WILD ONE 24 ATB

PEDAL JR Pedal VPE-229
MUDGUARD RPZ 24 55 black
CARRIER KTM 24" RACKTIME
KICKSTAND KTM CENTER 24-28" adjust
F LIGHTING AXA PIC015 LED 15Lux
R LIGHTING TRELOCK DUO FLAT
CATEGORY ● 2
SYSTEM WEIGHT 65 kg (permissible total weight)
WEIGHT 14,5 kg (without pedals)

WILD

ONE 20.6

⚙️ 1×6 SHIMANO TV21

⚙️ 3×7 SHIMANO TV21

COUNTRY

STAR 26.21

KIDS



FRAME 20" AL6061 KID WILD ONE K7030, 290mm
FORK 20" Suntour SF14-M3010-P
HEADSET Ahead set, semi-integr., water proof, black
STEM E60mm, R:15
HANDLEBAR KTM Line rizer20 520mm
GRIP VELO VLG-184-6AD2, L:76mm
BRAKE VELO VLG-184-7AD2, L:110mm
CHAINWHEEL V TEKTR0 TS325A / 855AL
CHAIN LASCO CF0136 36 127
SPROCKET KMC Z7 1/2"x3/32"

F. DERAILL. Shimano FTZ500-6 14-28
R. DERAILL. Shimano TV21-6
SHIFTER Shimano SL-RS36 6
F HUB Shimano DHC30003 28H Nut
R HUB FORMULA 28H FM-31R Nut
SPOKE RM 2.0 INOX, silver
RIM REMERX DRAGON 28H 406x19
TIRES RUBENA V41 WALRUS 47-406 20x1.75x2
SADDLE KTM Line CITY JR
SEATPOST KTM Line 27.2/320

PEDAL JR Pedal VPE-229
MUDGUARD RPZ 20 55 black
CARRIER KTM 20" RACKTIME
KICKSTAND KTM CENTER 16-20" adjust
F LIGHTING AXA PIC015 LED 15Lux
R LIGHTING TRELOCK DUO FLAT
CATEGORY ● 2
SYSTEM WEIGHT 63 kg (permissible total weight)
WEIGHT 12,7 kg (without pedals)



■ black matt (orange)
 ✓ 020252100 WILD ONE 20 ATB



FRAME 26" AL6061 KID COUNTRY STAR K7680-L, 420mm
FORK 26" Suntour SF15-NEX P 63
HEADSET RITCHEY LOGIC ZERO PRESS FIT, 1-1/8", H:9.4mm
STEM KTM Line 17"
HANDLEBAR KTM Line rizer20 620mm
GRIP KTM Dimond Grip 130mm black ring
BRAKE V TEKTR0 855AL
CHAINWHEEL Shimano TY501 42-34-24 165
CHAIN Shimano HG40
SPROCKET Shimano TZ500-7 14-34

F. DERAILL. Shimano TV700 TS
R. DERAILL. Shimano Altus M310DL-7
SHIFTER Shimano Altus ST-EF500 7
F HUB Shimano DHC30003 32H Nut
R HUB 32H QUANDO KT-A12R Nut
SPOKE RM 2.0 INOX, silver
RIM REMERX DRAGON 32H 559x19
TIRES IMPAC STREETPAC TwinSkin 47-559 26x1.75
SADDLE SELLE ROYAL Rio
SEATPOST KTM Line 27.2/300

PEDAL Onroad Pedal VPE-891 EPB
MUDGUARD RPZ 26 55 black matt
CARRIER KTM 26" RACKTIME
KICKSTAND KTM REAR 26-29" adjust
F LIGHTING AXA PIC015 LED 15Lux
R LIGHTING TRELOCK DUO FLAT
GUARD CATENA COMPACT
CATEGORY ● 2
SYSTEM WEIGHT 130 kg (permissible total weight)
WEIGHT 16,2 kg (without pedals)



■ lightgrey matt (darkblue)
 ✓ 020253200 COUNTRY STAR 26 D 37
 ✓ 020253202 COUNTRY STAR 26 D 42
 ✓ 020253207 COUNTRY STAR 26 D 47



■ lightgrey matt (darkblue)
 ✓ 020253500 COUNTRY STAR 26 E 37
 ✓ 020253503 COUNTRY STAR 26 E 43
 ✓ 020253511 COUNTRY STAR 26 E 51

WILDCAT

24.18

2x9 SHIMANO TY21

1x6 SHIMANO TY21

WILDCAT

20.6



FRAME	24" AL6061 KID WILD CAT 21 K7440, 350mm
FORK	24" RIGID steel
HEADSET	Head set VP MH-305C, STD:1-1/8", H:20mm
STEM	E40mm, L:150mm
HANDLEBAR	KTM Line rizer20 560mm
GRIP	VELO VLG-184-6AD2, L:76mm
BRAKE	V TEKTRO TS325A / 855AL
CHAINWHEEL	LASCO CF5843 42-32-22 140
CHAIN	KMC Z7 1/2"x3/32"
SPROCKET	Shimano FTZ500-6 14-28

F. DERAILL.	Shimano TY500 TS
R. DERAILL.	Shimano TY21-6
SHIFTER	Shimano SL-RS36 6
F HUB	Shimano DHC30003 28H Nut
R HUB	QUANDO 28H KT-A11R Nut
SPOKE	RM 2.0 INOX, silver
RIM	REMERX DRAGON 28H 507x19
TIRES	RUBENA V41 WALRUS 47-507 24x1.75x2
SADDLE	KTM Line CITY JR
SEATPOST	KTM Line 27.2/250

PEDAL	JR Pedal VPE-229
MUDGUARD	RPZ 24 55 black
CARRIER	KTM 24" RACKTIME
KICKSTAND	KTM CENTER 24-28" adjust
F LIGHTING	AXA PIC015 LED 15Lux
R LIGHTING	TRELOCK DUO FLAT
GUARD	CATENA COMPACT
CATEGORY	2
SYSTEM WEIGHT	64 kg (permissible total weight)
WEIGHT	13,9 kg (without pedals)

FRAME	20" AL6061 KID WILD CAT 6 K7040, 305mm
FORK	20" RIGID steel
HEADSET	Head set VP MH-305C, STD:1-1/8", H:20mm
STEM	E40mm, L:150mm
HANDLEBAR	KTM Line rizer20 520mm
GRIP	VELO VLG-184-6AD2, L:76mm
BRAKE	VELO VLG-184-1AD2, L:102mm
CHAINWHEEL	V TEKTRO TS325A / 855AL
CHAIN	LASCO CF0136 36 127
SPROCKET	KMC Z7 1/2"x3/32"

F. DERAILL.	Shimano FTZ500-6 14-28
R. DERAILL.	Shimano TY21-6
SHIFTER	Shimano SL-RS36 6
F HUB	Shimano DHC30003 28H Nut
R HUB	FORMULA 28H FM-31R Nut
SPOKE	RM 2.0 INOX, silver
RIM	REMERX DRAGON 28H 406x19
TIRES	RUBENA V41 WALRUS 47-406 20x1.75x2
SADDLE	KTM Line CITY JR
SEATPOST	KTM Line 27.2/250

PEDAL	JR Pedal VPE-229
MUDGUARD	RPZ 20 55 black
CARRIER	KTM 20" RACKTIME
KICKSTAND	KTM CENTER 16-20" adjust
F LIGHTING	AXA PIC015 LED 15Lux
R LIGHTING	TRELOCK DUO FLAT
GUARD	BELD
CATEGORY	2
SYSTEM WEIGHT	62 kg (permissible total weight)
WEIGHT	12 kg (without pedals)



aqua (iceblue)
020254200 WILDCAT 24



rose (purple)
020255200 WILDCAT 20

KID 12.1

ORANGE/BLACK



FRAME	12"x205mm ALLOY	DRAKE	ALLOY V-BRAKE	TIRE	KENDA MTB 12x1/2"x2-1/4"
FORK	Rigide STEEL 12"x172mm	DRAKEKLEV.	3 FINGER KID ALLOY	MUDGUARD	Front & Rear Plastic
BAR	KTM ALLOY, 480mm, RISE 60mm x 10DEG	CRANKSET	Single 28T, 102mm, FULL CHAINGUARD	CATEGORY	0
STEM	KTM ALLOY 60mm	WHEELSET	KTM Line ALLOY 12"	SYSTEM WEIGHT	44 kg (permissible total weight)
		WEIGHT			8,5 kg with pedal

 **orange (black)**
302832112 KID 12.1 orange/black

KID 16.1

ONETUBE



FRAME	16"x220mm ALLOY	DRAKE	ALLOY V-BRAKE	TIRE	KENDA MTB 16x1.75
FORK	Rigide STEEL 16"x179mm	DRAKEKLEV.	3 FINGER KID ALLOY	MUDGUARD	Front & Rear Plastic
BAR	KTM ALLOY 60mm	CRANKSET	Single 28T, 102mm, FULL CHAINGUARD	CATEGORY	0
STEM	KTM ALLOY, 480mm, RISE 60mm x 10DEG.	WHEELSET	KTM Line ALLOY 12"	SYSTEM WEIGHT	45 kg (permissible total weight)
		WEIGHT			9,5 kg with pedal

 **white (iceblue)**
302820116 KID 16.1 Onetube

KID 12.1

WHITE/PINK



FRAME	12"x205mm ALLOY	DRAKE	ALLOY V-BRAKE	TIRE	KENDA MTB 12x1/2"x2-1/4"
FORK	Rigide STEEL 12"x172mm	DRAKEKLEV.	3 FINGER KID ALLOY	MUDGUARD	Front & Rear Plastic
BAR	KTM ALLOY, 480mm, RISE 60mm x 10DEG	CRANKSET	Single 28T, 102mm, FULL CHAINGUARD	CATEGORY	0
STEM	KTM ALLOY 60mm	WHEELSET	KTM Line ALLOY 12"	SYSTEM WEIGHT	44 kg (permissible total weight)
		WEIGHT			8,5 kg with pedal

 **white (pink)**
302830112 KID 12.1 white/pink

KID 16.1

MTB



FRAME	16"x220mm ALLOY	DRAKE	ALLOY V-BRAKE	TIRE	KENDA MTB 16x1.75
FORK	Rigide STEEL 16"x179mm	DRAKEKLEV.	3 FINGER KID ALLOY	MUDGUARD	Front & Rear Plastic
BAR	KTM ALLOY 60mm	CRANKSET	Single 28T, 102mm, FULL CHAINGUARD	CATEGORY	0
STEM	KTM ALLOY, 480mm, RISE 60mm x 10DEG.	WHEELSET	KTM Line ALLOY 12"	SYSTEM WEIGHT	45 kg (permissible total weight)
		WEIGHT			9,5 kg with pedal

 **black (orange)**
302820216 KID 16.1 MTB

BESTIMMUNGSGEMÄSSER

GEBRAUCH

INTENDED USE

Fahrradrahmen und die dazu gehörigen Komponenten werden generell für unterschiedliche Einsatzzwecke und Nutzungsarten konzipiert. Jeder Fahrradtyp ist dabei für einen bestimmten Einsatzzweck gedacht. KTM stellt viele Kategorien von Mountainbikes, Straßen-, Renn- und Cyclocrossrädern, Trekking-, Touren-, Lasten- und Reiserädern sowie Kinder- und Jugendrädern her.

Wird bei der Nutzung des Fahrrades die Belastungsgrenze überschritten, so können das Fahrrad bzw. die dazu gehörigen Komponenten beschädigt werden. Falls dies der Fall ist, können Komponenten aufgrund von Vorschäden bereits bei einer viel geringeren Belastung versagen. Aus diesem Grund ist es wichtig, das Fahrrad entsprechend dem Einsatzzweck zu nutzen. Für Schäden, die aus der Nichteinhaltung der jeweiligen Belastungsgrenzen resultieren, bzw. welche aus Fehlgebrauch des Fahrrades stammen, haften Hersteller und Fachhändler nicht. Um die langfristige Sicherheit Ihres erworbenen Produkts auf Dauer gewährleisten zu können, ist die Einhaltung der vom Hersteller in der Gebrauchsanweisung vorgeschriebenen Betriebs-, Wartungs- und Instandhaltungsvorgaben zwingend erforderlich.

Machen Sie sich dazu vor allem mit den Kapiteln „Wartungs- und Pflegeintervalle“ sowie „Gewährleistung und Garantie“ vertraut.

Im nachstehenden Abschnitt werden unterschiedliche Kategorien definiert, welche sämtliche Einsatzzwecke und Belastungsgrenzen berücksichtigen. Ergänzend zu diesem Abschnitt empfehlen wir Ihnen, die Anleitungen der Komponentenhersteller bezüglich Informationen über bestimmungsgemäßen Gebrauch heranzuziehen.

KATEGORISIERUNG

Die KTM Fahrrad GmbH gibt die Kategorien 0-5 bzw. EPAC-Kategorien E0-E5 vor, welche sich vor allem in ihren Einsatzzwecken deutlich voneinander unterscheiden. Die verschiedenen Kategorien sind auf den nachfolgenden Seiten beschrieben.

Die zutreffende Kategorie ist direkt am Fahrrad/EPAC, im Bereich des Unter- bzw. Sattelrohrs, in Form eines Aufklebers (Fahrrad-Aufkleber - Symbolabbildung 1 / EPAC Aufkleber - Symbolabbildung 2) vermerkt. Zusätzlich informiert dieser Aufkleber über sämtliche relevante Daten Ihres Fahrrades/EPACs.

Bitte beachten Sie die Kategorie Ihres Fahrrades/EPACs und informieren Sie sich genau über die jeweils zutreffenden Einsatzzwecke bzw. Belastungsgrenzen. Auf diesem Sticker befindet sich bei EPACs auch die CE-Kennzeichnung.

Mit der CE-Kennzeichnung erklärt der Hersteller gemäß EU-Verordnung, „dass das Produkt den geltenden Anforderungen entspricht, die in den Harmonisierungsrechtsvorschriften der Gemeinschaft über ihre Anbringung festgelegt sind.“

Bicycle frames and the pertinent components are designed for various functions and types of use. Each type of bicycle is designed with a specific use in mind. KTM manufactures a whole host of categories of mountain bikes, road bicycles, racing bikes and cyclo-cross bikes, trekking bikes, touring bikes, cargo bicycles and expedition bikes as well as bicycles for children and youngsters.

If the maximum load is exceeded while using the bike, the bicycle and its components may be damaged. If your bicycle is damaged, it may fail even when placed under a lesser degree of further stress due to preliminary damage. Therefore, please make sure to use the bicycle only for its intended purpose. The manufacturer and specialist dealer do not accept liability for damage resulting from non-observance of the respective maximum load or from improper use of the bicycle. In order to ensure the long-term safety of your purchased product, observing the operating, maintenance and servicing instructions contained in the manufacturer's operating manual is obligatory.

In particular, please familiarize yourself with the chapters "Maintenance and Service Intervals" and "Warranty" of the user manual.

The following section defines various categories which specify all types of intended use and maximum load levels. In addition, we recommend consulting the component manufacturers' instructions relating to proper use.

CATEGORIZATION

KTM Fahrrad GmbH specifies Categories 0-5 or E0-E5, which are clearly distinguished from one another primarily by their intended purpose. The different categories are described on the following pages.

A label is positioned on the bicycle's down- or seat tube (bicycle-sticker - illustration 1 / EPAC sticker - illustration 2). In addition, this label informs about all relevant data of your bicycle/EPAC.

Please note the category of your bike / EPAC and inform yourself exactly about the respectively applicable purposes or load limits. This sticker also contains the CE mark on EPACs.

With the CE mark, the manufacturer declares in accordance to the EU regulation "that the product complies with the applicable requirements set out in the Community harmonization legislation for its installation."



Symbolabbildung 3 "Short Fender"
Illustration 3 "Short Fender"

Achtung: Werden bei Offroad Modellen zusätzlich Gepäckträger, Schutzbleche oder ein Kettenschutz montiert, ändert sich die Kategorie automatisch auf 2 bzw. E2. Ausgenommen sind sogenannte „Short Fenders“ (Symbolabbildung 3), die ohne Streben an der Gabel oder am Rahmen bzw. Sattel montiert werden können.

Attention: If additional luggage racks, mudguards or chain guards are mounted on offroad models, the category automatically changes to 2 or E2. Exceptions are so-called "short fenders" (Illustration 3), which can be mounted on the fork, frame or saddle without strays.



Symbolabbildung 1 "Fahrrad-Aufkleber"
Illustration 1 "bicycle-label"



Symbolabbildung 2 "EPAC-Aufkleber"
Illustration 2 "EPAC-label"

	Fahrrad-Aufkleber	EPAC-Aufkleber	Bicycle-Label	EPAC-Label
Zeile 1 - 2:	Name und Anschrift des Herstellers des Fahrrades	Name und Anschrift des Herstellers des EPACs	Name and address of the bike manufacturer	Name and address of the EPAC manufacturer
Zeile 3-4:	Modellbezeichnung inkl. spezifischer Baugruppennummer	Modellbezeichnung inkl. spezifischer Baugruppennummer	Model designation including specific assembly number	Model designation including specific assembly number
Zeile 5:	Höchstzulässiges Gesamtgewicht des Fahrrades*	Herstellungsjahr des EPACs	Maximum permissible total weight of the bikes*	Year of manufacture of the EPAC
Zeile 6:		Art der Maschine (EPAC), Nenndauerleistung des Motors (250 Watt), maximale Unterstützungsgeschwindigkeit des Motors (25 km/h).		Type of machine (EPAC). Continuous rated power of the motor (250 watts). Maximum support speed of the motor (25 km/h).
Zeile 7:		Höchstzulässiges Gesamtgewicht des EPACs*		Maximum permissible total weight of the EPAC*
Zeile 8:	ISO 4210-2: Fahrräder - Sicherheitstechnische Anforderungen an Fahrräder		ISO 4210-2 = Bicycles - Safety requirements for bicycles	
Zeile 11-12:		2006/42/EC = Maschinenrichtlinie 2014/30/EC = EMV-Richtlinie EN 15194 = Fahrräder - Elektromotorisch unterstützte Räder - EPAC Fahrräder		2006/42/EC = Machinery Directive 2014/30/EC = EMC Directive EN 15194 = Bicycles - Electromotive Assisted Wheels - EPAC Bicycles

*Das höchstzulässige Gesamtgewicht des jeweiligen Fahrradmodells stellt die Summe aus Fahrradgewicht + Fahrer + Zuladung dar und darf keinesfalls überschritten werden

*The maximum permissible total weight of the respective bicycle model represents the sum of bicycle weight + rider + luggage and must not be exceeded under any circumstances.

KATEGORIE 0 / E0



FAHRRAD-TYPEN

Kinderfahrräder

CHARAKTERISTIK DER KATEGORIE 0 / E0

Diese Fahrräder sind ausschließlich für Kinder gedacht. Fahrräder der Kategorie 0 / E0 dürfen keinesfalls von Jugendlichen oder Erwachsenen verwendet werden. Kinder dürfen niemals ohne Aufsicht Rad fahren. Außerdem sollten Kinder stets abseits von Straßenverkehr und anderen Gefahren oder Hindernissen und angepasst an ihre Fertigkeiten fahren.

ERLAUBTER EINSATZ

Die Verwendung von Fahrrädern aus der Kategorie 0 / E0 ist nur unter elterlicher Aufsicht gestattet.

NICHT ERLAUBTER EINSATZ

Kinder dürfen nicht in der Nähe von Gefällen, Bordsteinen, Treppen, Geländeabbrüchen, Kanaldeckeln sowie auf Wegen, die von Kraftfahrzeugen genutzt werden, Fahrrad fahren.

WISSENSWERTES

Die maximal einstellbare Sattelhöhe (siehe Kapitel „Anpassungen am Fahrrad“) darf nicht weniger als 435mm betragen sowie 635mm nicht übersteigen. Die Sattelhöhe stellt den senkrechten Abstand zwischen Boden und Oberkante des Sattels dar (Abb. 6).

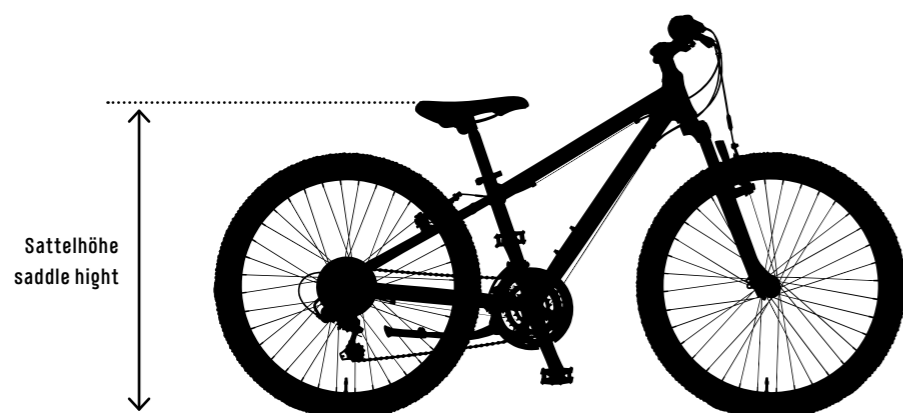

TYPE OF BICYCLE

Children's bikes

FEATURES OF CATEGORY 0 / E0

These bikes are intended exclusively for children. Category 0 / E0 bicycles must not be used by youngsters or adults. Children should always be under the supervision of an adult while riding the bike. Furthermore, children should always cycle well away from road traffic and other dangers or obstacles and in accordance with their individual skills.

PERMITTED USE

The use of Category 0 / E0 bicycles is only allowed under the supervision of an adult.

NOT PERMITTED FOR USE

Children must not ride their bike in the vicinity of downward slopes, kerbstones, stairs, precipices, manhole covers as well as on paths used by motor vehicles.

FURTHER INFORMATION

The maximum adjustable saddle height (see chapter "Adjusting Your Bicycle") must not be less than 435 mm, while not exceeding 635 mm. The saddle height is the vertical distance between floor and top edge of the saddle (fig. 3).

KATEGORIE 1 / E1



FAHRRAD-TYPEN

Road Race, Time Trial, Triathlon

CHARAKTERISTIK DER KATEGORIE 1 / E1

Hierbei handelt es sich um die Kategorie von Fahrrädern, welche für den Einsatz auf gepflasterten Straßen oder glatten Fahrbahnen ausgelegt sind. Der Kontakt zwischen Reifen und Fahrbahn kann dabei unbeabsichtigt verloren gehen.

ERLAUBTER EINSATZ

Ausschließlich für den Einsatz auf asphaltierten Straßen.

NICHT ERLAUBTER EINSATZ

Für Offroad und Einsatz mit Gepäckträger oder Fahrradtaschen nicht geeignet.

WISSENSWERTES

Länderspezifisch kann es möglich sein, dass zum legalen Einsatz auf öffentlichen Straßen eine Nachrüstung mit Scheinwerfer, Reflektoren, Schutzblechen etc. nötig ist, um den nationalen Gesetzen zu entsprechen. Die für Trainingszwecke oder Wettkämpfe erforderliche sicherheitstechnische Ausstattung des Fahrrades aus Kategorie 1 wird mitgeliefert und muss vom Benutzer oder Fachmann regelmäßig überprüft und – falls erforderlich – instandgesetzt werden. Bei Schäden, welche aus der Benutzung des Rennrades im Gelände, aus Überladung und aus nicht ordnungsgemäßer Beseitigung von Mängeln resultieren, haften Hersteller und Fachhändler nicht.

TYPE OF BICYCLE

Road Race, Time Trial, Triathlon

FEATURES OF CATEGORY 1 / E1

This category refers to bicycles that are designed to be ridden on paved or smooth roads. The tyres may unintentionally lose contact with the road.

PERMITTED USE

Only for use on paved roads.

NOT PERMITTED FOR USE

Not suitable for off-road use in combination with luggage rack or panniers.

FURTHER INFORMATION

In some countries it may be necessary to retrofit the bicycle with head lights, reflectors, mudguards, etc. in order to use the bike on public roads in compliance with the national legislation. The Category 1 bicycle comes with the safety-related equipment required for training purposes or competitions. This equipment must be checked and if necessary repaired by the user or a trained specialist at regular intervals. The manufacturer and specialist dealer do not accept any liability for damage resulting from off-road cycling, overloading or incorrect remedy of defects.

KATEGORIE 2/E2

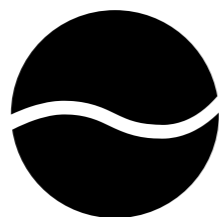

FAHRRAD-TYPEN

City, Trekking Onroad, Trekking Offroad, Cyclocross, Mountainbike Casual

CHARAKTERISTIK DER KATEGORIE 2 / E2

Hierbei handelt es sich um die Kategorie von Fahrrädern, welche den Einsatzzweck der Kategorie 1/E1 und zusätzlich ungepflasterte Landstraßen und Schotterwege sowie Strecken mit mäßiger Steigung / Gefälle umfasst. Kontakt mit unebenem Untergrund ist möglich. Die Reifen können dadurch den Bodenkontakt verlieren. Sprünge dürfen eine Höhe von 15 cm nicht überschreiten.

ERLAUBTER EINSATZ

Für asphaltierte Straßen, gut befestigte Schotterwege sowie Fahrradwege.

NICHT ERLAUBTER EINSATZ

Für den darüber hinaus gehenden Offroad-Einsatz sowie die Verwendung als Mountainbike bzw. für die Durchführung diverser Freestyle-Tricks nicht geeignet. Manche dieser Räder verfügen zwar über Federungssysteme, diese dienen jedoch lediglich dem Komfort, nicht aber der Geländetauglichkeit.

WISSENSWERTES

Fahrräder dieser Kategorie entsprechen bis auf Ausnahmen auf Grund ihrer Konzeption und Ausstattung, wie aktive (Rücklicht, Scheinwerfer) und passive (Reflektoren) Beleuchtungseinrichtungen, den gesetzlichen Anforderungen des Straßenverkehrs. Zudem ist die Nutzung auch auf für den Fahrradverkehr freigegebenen Feld- und Waldwegen gestattet. Die für diesen Einsatzzweck erforderliche sicherheitstechnische Ausstattung wurde mitgeliefert und muss vom Benutzer oder Fachmann regelmäßig überprüft und – falls erforderlich – instandgesetzt werden.

Einige Fahrräder dieser Kategorie entsprechen allerdings nicht den gesetzlichen Anforderungen des Straßenverkehrs und sind somit als Sportgeräte anzusehen. Falls Ihr Fahrrad nicht mit aktiven (Rücklicht, Scheinwerfer) und passiven (Reflektoren) Beleuchtungseinrichtungen ausgestattet ist, sind diese vor der Nutzung auf öffentlichen Straßen mit Komponenten, entsprechend der jeweiligen nationalen Gesetze und Vorschriften nachzurüsten.

TYPE OF BICYCLE

City, Trekking On-road, Trekking Off-road, Cyclocross, Mountain bike casual

FEATURES OF CATEGORY 2 / E2

This category refers to bicycles that can be used on unpaved roads and gravel paths as well as trails with moderate inclines / slopes in addition to the intended use of Category 1/E1. Contact with uneven ground poses no problems. Tyres may lose contact with the road. Jumps must not exceed a height of 15 cm.

PERMITTED USE

For paved roads, hard-surface gravel paths as well as cycle paths.

NOT PERMITTED FOR USE

Not suitable for off-road use that goes beyond the intended purpose. Furthermore, it should not be used as mountain bike or for freestyle tricks. Some of these bikes comprise suspension systems that enhance comfort, but do not increase off-road capability.

FURTHER INFORMATION

Although there are some exceptions, Category 2 bicycles comply with the legal requirements for participation in road traffic thanks to their design and equipment such as active (rear light, head light) and passive (reflectors) lighting systems. On top of this, these bikes can also be used on unpaved field and forest trails where bicycles are allowed. Category 2 bikes come with the safety-related equipment required for this type of use. This equipment must be checked and if necessary repaired by the user or a trained specialist at regular intervals.

However, some bicycles of this category do not comply with the legal requirements for road traffic and must therefore be regarded as sports equipment. Bicycles that do not comprise active (rear light, head light) and passive (reflectors) lighting systems need to be retrofitted with components compliant with the respective national legislation and regulations prior to usage on public roads.

KATEGORIE 3/E3



FAHRRAD-TYPEN

Mountainbike: Cross Country, Marathon, Tour

CHARAKTERISTIK DER KATEGORIE 3 / E3

Hierbei handelt es sich um die Kategorie von Fahrrädern, welche den Einsatzzweck der Kategorien 1/E1 und 2/E2 beinhaltet. Zusätzlich umfasst diese Kategorie unerschlossene Strecken sowie technische Bereiche. Sprünge bis zu 60 cm sind hier inbegriffen.

ERLAUBTER EINSATZ

Von leichtem bis hin zu anspruchsvollem Gelände (kleine Hindernisse, wie Wurzeln, Steine und Rinnen auf losem sowie festem Untergrund), während Cross-Country- oder Wettkampfeinsätzen. Cross-Country-, Marathon- und Tour-Komponenten (Reifen, Federung, Rahmen, Antrieb) verfügen über geringes Gewicht und sind für Wendigkeit und Geschwindigkeit ausgelegt.

NICHT ERLAUBTER EINSATZ

Für alle extremen Formen des Fahrens bzw. Springens wie z.B. Freeriding, Enduro, Downhill, Freestyle-Tricks u.dgl. nicht geeignet.

WISSENSWERTES

Diese Fahrräder sind aufgrund ihrer Konzeption und Ausstattung nicht dazu bestimmt, auf öffentlichen Straßen eingesetzt zu werden. Vor der Nutzung auf öffentlichen Straßen muss das Rad, entsprechend der jeweiligen nationalen Gesetze und Vorschriften, mit Beleuchtung, Schutzblech etc. nachgerüstet werden. Die für den Einsatz im Gelände erforderliche sicherheitstechnische Ausstattung wird mitgeliefert und muss vom Benutzer oder Fachmann regelmäßig überprüft und – falls erforderlich – instandgesetzt werden. Cross-Country-, Marathon- und Tour-Mountainbikes sind leichter, bergauf schneller und wendiger als All Mountain-, Trail- und Enduro-Mountainbikes. Antriebseffizienz und Klettereigenschaften werden bei Fahrrädern der Kategorie 3 über Robustheit gesetzt.

TYPE OF BICYCLE

Mountain bike: Cross Country, Marathon, Tour

FEATURES OF CATEGORY 3 / E3

This category refers to bicycles encompassing the intended use described in Categories 1/E1 and 2/E2. In addition, this category is suitable for undeveloped terrain as well as technical applications. Jumps up to a height of 60 cm are included in this field of use.

PERMITTED USE

Ranging from easy to challenging terrain (small obstacles such as roots, stones and trenches on loose as well as solid ground), for cross-country use or competitions. Cross-country, marathon and tour components (tyres, suspension, frame, drive unit) are lightweight and are particularly designed for excellent manoeuvrability and speed.

NOT PERMITTED FOR USE

Not suitable for extreme forms of riding or jumping such as freeriding, enduro, downhill, freestyle tricks, etc.

FURTHER INFORMATION

Due to their special design and equipment, these bicycles are not intended for use on public roads. Prior to cycling on public roads, the bicycle must be retrofitted with lighting, mudguard, etc. in compliance with the applicable national legislation and regulations. Category 3 bikes come with the safety-related equipment required for off-road usage. This equipment must be checked and if necessary repaired by the user or a trained specialist at regular intervals. Cross-country, marathon and tour bikes are more lightweight, faster going uphill and boast better manoeuvrability than all-mountain bikes, trail and enduro mountain bikes. With Category 3 bikes, propulsion efficiency and climbing capabilities are given priority over sturdiness.

KATEGORIE 4/E4



FAHRRAD-TYPEN

Mountainbike: Trail, All Mountain, Enduro

CHARAKTERISTIK DER KATEGORIE 4 / E4

Hierbei handelt es sich um die Kategorie von Fahrrädern, welche den Einsatzzweck der Kategorien 1/E1, 2/E2 und 3/E3 beinhaltet. Darüber hinaus umfasst diese Kategorie eingeschränkten Downhill-Einsatz. Downhills dürfen bis zu einer Geschwindigkeit von 40 km/h ausgeübt werden, solange Sprünge eine Höhe von 120 cm nicht überschreiten. Der Einsatz eines Fahrrades unter diesen Bedingungen ist stark von der Erfahrung und den Fähigkeiten des Fahrers abhängig.

ERLAUBTER EINSATZ

Fahrräder aus dieser Kategorie sind robuster und solider gebaut als Cross-Country-, Marathon- oder Tour-Mountainbikes. Auf Grund des höheren Federweges kann anspruchsvolleres Gelände mit größeren Hindernissen und Sprüngen bewältigt werden. Fahrräder aus dieser Kategorie decken einen großen Einsatzbereich ab.

NICHT ERLAUBTER EINSATZ

Einsatzgebiete, die den genannten Verwendungszweck überschreiten.

WISSENSWERTES

Diese Fahrräder sind aufgrund ihrer Konzeption und Ausstattung nicht dazu bestimmt auf öffentlichen Straßen eingesetzt zu werden. Vor der Nutzung auf öffentlichen Straßen muss das Rad, entsprechend der jeweiligen nationalen Gesetze und Vorschriften, mit Beleuchtung, Schutzblech etc. nachgerüstet werden. Die für den Einsatz im Gelände erforderliche sicherheits-technische Ausstattung wird mitgeliefert und muss vom Benutzer oder Fachmann regelmäßig überprüft und – falls erforderlich – instandgesetzt werden.

Da diese Kategorie eine Vielzahl von Einsatzgebieten abdeckt, ist es unerlässlich, die Grenzen des Einsatzzwecks dieser Räder zu kennen.

TYPE OF BICYCLE

Mountain bike: Trail, All Mountain, Enduro

FEATURES OF CATEGORY 4 / E4

This category refers to bicycles encompassing the intended use of Categories 1/E1, 2/E2 and 3/E3. In addition, this category is suitable for limited downhill use. Downhill rides are possible up to a speed of 40 km/h as long as the jumps do not exceed a height of 120 cm. Riding a bicycle under these conditions depends heavily on the rider's experience and capabilities.

PERMITTED USE

Category 4 bicycles have a particularly sturdy and solid construction compared to cross-country, marathon or tour mountain bikes. Due to the longer suspension travel, it is possible to tackle bigger obstacles and jumps. Bicycles of this category cover a broad range of applications.

NOT PERMITTED FOR USE

Fields of use which go beyond the mentioned intended purpose.

FURTHER INFORMATION

Due to their special design and equipment, these bicycles are not intended for use on public roads. Prior to cycling on public roads, the bicycle must be retrofitted with lighting, mudguard, etc. in compliance with the applicable national legislation and regulations. Category 4 bikes come with the safety-related equipment required for off-road usage. This equipment must be checked and if necessary repaired by the user or a trained specialist at regular intervals.

As this category covers a wide range of applications, it is vital to know the limits of the intended purpose for these bicycles.

KATEGORIE 5/E5



FAHRRAD-TYPEN

Fahrradtypen Mountainbike: Gravity, Freeride, Downhill

CHARAKTERISTIK DER KATEGORIE 5 / E5

Hierbei handelt es sich um die Kategorie von Fahrrädern, welche den Einsatzzweck der Kategorien 1/E1, 2/E2, 3/E3 und 4/E4 beinhaltet. Die Fahrräder sind zudem für Sprünge jeder Art bei darauffolgender Landung im abschüssigen Geländebereich sowie Geschwindigkeiten über 40 km/h ausgelegt. Die Verwendung in grobem, unwegsamem Gelände ist ebenfalls erlaubt. Der Einsatz eines Fahrrades unter diesen Bedingungen ist stark von der Erfahrung und den Fähigkeiten des Fahrers abhängig.

ERLAUBTER EINSATZ

Fahrräder für den oben genannten Einsatzzweck ermöglichen das Fahren in selektivem Gelände. Gravity-, Freeride-, und Downhill-Bikes sind äußerst robust gebaut und bieten sehr viel Federweg um Hindernisse bestmöglich bewältigen zu können. Aufgrund der hohen Belastung ist ein besonders pfleglicher und sorgsamer Umgang mit den Komponenten von Nöten.

NICHT ERLAUBTER EINSATZ

Verwendung über den persönlichen Grenzbereich.
Lassen Sie daher vernünftige Selbsteinschätzung walten.

WISSENSWERTES

Diese Fahrräder sind aufgrund ihrer Konzeption und Ausstattung nicht dazu bestimmt auf öffentlichen Straßen eingesetzt zu werden. Vor der Nutzung auf öffentlichen Straßen muss das Rad, entsprechend der jeweiligen nationalen Gesetze und Vorschriften, mit Beleuchtung, Schutzblech etc. nachgerüstet werden. Die für den Einsatz im Gelände erforderliche sicherheits-technische Ausstattung wird mitgeliefert und muss vom Benutzer oder Fachmann regelmäßig überprüft und – falls erforderlich – instandgesetzt werden. Wenn Sie beabsichtigen im Gelände zu fahren, welches dieser Kategorie entspricht, sollten Sie geeignete Sicherheitsmaßnahmen, wie beispielsweise häufigere Wartungsintervalle, ergreifen. Legen Sie großen Wert auf persönliche Sicherheitsausrüstung, wie z.B. einen geeigneten Helm und Protektoren. Bitte beachten Sie, dass Fehleinschätzung oder das Überschätzen der eigenen Fähigkeiten in dieser Kategorie schnell zu einem Unfall mit schweren Verletzungen oder gar Todesfolge führen kann.

TYPE OF BICYCLE

Mountain bike: Gravity, Freeride, Downhill

FEATURES OF CATEGORY 5 / E5

This category refers to bicycles encompassing the intended use of Categories 1/E1, 2/E2, 3/E3 and 4/E4. Furthermore, these bicycles are ideally suited for any kind of jumps with subsequent landing on sloping terrain as well as speeds up to 40 km/h. They can also be used in rough and difficult terrain. Riding a bicycle under these conditions depends heavily on the rider's experience and capabilities.

PERMITTED USE

Bicycles with the aforementioned intended use allow for riding in selective terrain. Gravity, freeride and downhill bikes have an extremely sturdy design and provide long suspension travel in order to successfully tackle obstacles. Due to the high stress, please make sure that you take good care of the components.

NOT PERMITTED FOR USE

Usage beyond your personal capabilities.
Therefore, knowing your capabilities and limitations is essential.

FURTHER INFORMATION

Due to their special design and equipment, these bicycles are not intended for use on public roads. Prior to cycling on public roads, the bicycle must be retrofitted with lighting, mudguard, etc. in compliance with the applicable national legislation and regulations. Category 4 bikes come with the safety-related equipment required for off-road usage. This equipment must be checked and if necessary repaired by the user or a trained specialist at regular intervals. If you intend to go off-road in terrain for which this category is suitable, you should take appropriate safety measures such as adhering to frequent maintenance intervals. Please attach the utmost importance to wearing safety equipment such as a suitable helmet and protectors. Bear in mind that misjudging or overestimating your own riding abilities in this category may easily result in accidents causing serious injuries or, at worst, death.

MTB

GEO

- A** Größe in cm
Size in cm
- A** Größe
Size
- A** Größe in Zoll
Size in inch
- B** Sitzrohrlänge
Seat tube length
- C** Oberrohrlänge
Top tube length
- D** Sitzwinkel
Seat angle
- E** Lenkwinkel
Head angle
- F** Steuerrohrlänge
Head tube length
- G** Kettenstrebenlänge
Chainstay length
- H** Radstand
Wheelbase
- I** Stack
Stack
- J** Reach
Reach
- K** Überstandshöhe
Standover height
- L** Tretlagerabsenkung
BB drop

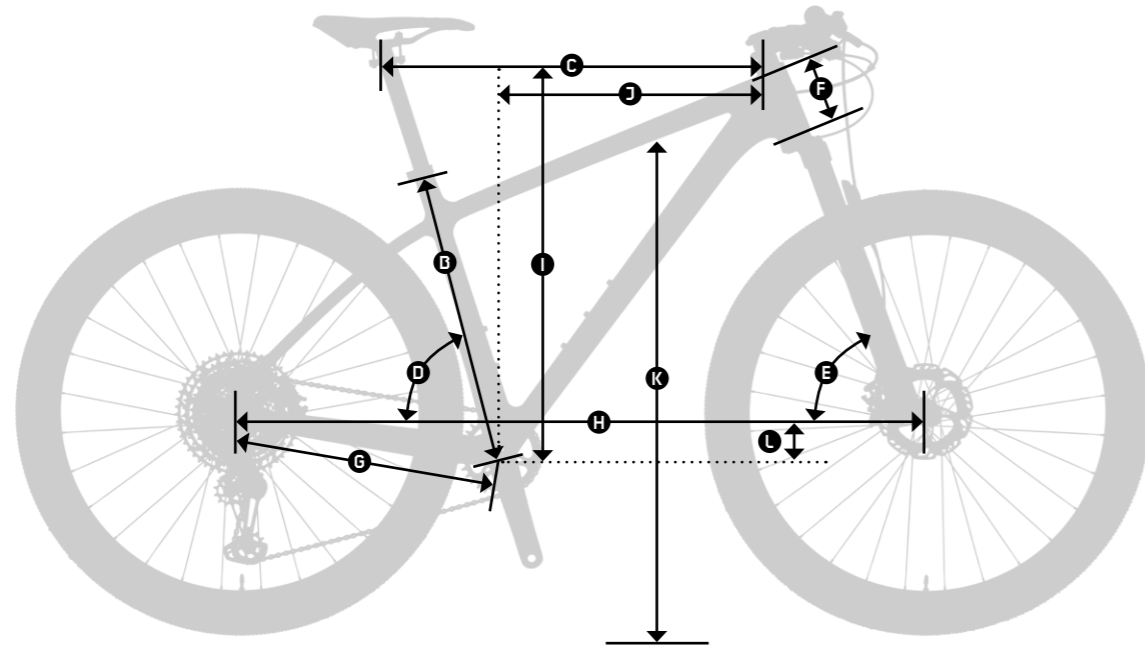

	A	A	A	B	C	D	E	F	G	H	I	J	K	L
PROWLER 29"	43	S	17	430	590	76,5*(71°)	66,5°	90	436	1186	606	445	805	30
	48	M	19	430	610	76,5*(71,5°)	66,5°	105	436	1209	620	461	805	30
	53	L	21	430	640	76,5*(72°)	66,5°	120	436	1241	634	488	805	30
SCARP MT 29"	38	XS	15	380	583	74*(69°)	67,5°	95	435	1131	593	413	790	38
	43	S	17	430	603	74*(69,5°)	67,5°	105	435	1152	603	431	790	38
	48	M	19	450	623	74*(70°)	67,5°	115	435	1174	612	448	790	38
	53	L	21	480	643	74*(70,5°)	67,5°	125	435	1195	622	466	796	38
SCARP 29"	38	XS	15	400	580	75*(70°)	68,5°	95	435	1131	1124	586	423	45
	43	S	17	430	600	75*(70,5°)	68,5°	105	435	1152	1145	596	440	45
	48	M	19	450	620	75*(71°)	68,5°	115	435	1174	1166	605	458	45
	53	L	21	480	640	75*(71,5°)	68,5°	125	435	1195	1187	614	475	45
SCARP 294	43	S	17	430	600	74,5/72,7°	70,0°	105	441	1129	603	433	775	45
	48	M	19	480	620	74,5/72,9°	70,0°	115	441	1149	612	450	772	45
	53	L	21	530	640	74,5/73,0°	70,0°	125	441	1170	621	468	771	45
MYROON 29"	38	XS	15	380	580	74,5/73,0°	71,0°	95	430	1074	599	414	761	70
	43	S	17	430	600	74,5/73,0°	71,0°	105	430	1095	608	431	772	70
	48	M	19	480	620	74,5/73,0°	71,0°	115	430	1116	618	449	803	70
	53	L	21	530	640	74,5/73,0°	71,0°	125	430	1136	627	466	832	70
ULTRA EVO 29"	38	XS	15	360	580	75,0°	66,5°	90	440	1143	584	423	719	60
	43	S	17	410	600	75,0°	66,5°	90	440	1163	584	443	738	60
	48	M	19	460	620	75,0°	66,5°	105	440	1185	598	460	769	60
	53	L	21	510	640	75,0°	66,5°	120	440	1208	612	476	802	60
	57	XL	22,5	550	660	75,0°	66,5°	140	440	1231	630	491	830	60
ULTRA 29"	38	XS	15	380	565	75,0°	71,0°	95	445	1080	899	405	733	70
	43	S	17	430	585	75,0°	71,0°	110	445	1101	613	421	759	70
	48	M	19	480	605	75,0°	71,0°	125	445	1122	627	437	789	70
	53	L	21	530	625	75,0°	71,0°	140	445	1143	642	453	820	70
	57	XL	22,5	570	645	75,0°	71,0°	160	445	1165	660	468	849	70
ULTRA 27"	38	XS	15	380	565	74,0°	70,0°	110	435	1068	579	399	724	50
	43	S	17	430	585	74,0°	70,0°	125	435	1089	593	415	750	50
	48	M	19	480	605	74,0°	70,0°	140	435	1110	607	431	780	50
ULTRA GLORIETTE 27"	35	XS	13,5	350	547	72,0°	70,0°	125	435	1028	593	354	701	50
	42	S	16,5	420	559	72,0°	71,0°	140	435	1030	611	360	737	50
CHICAGO 29"	38	XS	15	400	570	73,0°	70,5°	120	455	1070	616	381	782	62
	43	S	17	430	589	73,0°	70,5°	120	455	1090	617	401	791	62
	48	M	19	480	607	73,0°	71,0°	125	455	1102	623	416	818	62
	53	L	21	530	626	73,0°	71,0°	137	455	1122	634	432	847	62
	57	XL	22,5	570	643	73,0°	71,0°	150	455	1139	647	445	872	62
CHICAGO 27"	36	XS	14	380	554	73,0°	70,0°	120	435	1046	589	374	751	47
	43	S	17	430	575	73,0°	70,0°	125	435	1067	593	393	776	47
	48	M	19	480	594	73,0°	70,0°	137	435	1087	605	409	805	47
	53	L	21	530	612	73,0°	70,0°	150	435	1105	617	423	835	47
PENNY LANE CLASSIC 27"	35	XS	13,5	350	547	72,0°	70,0°	125	435	1018	597	353	682	47
PENNY LANE DISC 27"	42	S	16,5	420	559	72,0°	71,0°	137	435	1030	611	361	723	47
	47	M	18,5	470	590	72,0°	71,0°	155	435	1061	625	387	748	47
	52	L	20,5	520	596	72,0°	71,0°	160	435	1065	636	390	793	47

ROAD

GEO

- A** Größe in cm
Size in cm
- A** Größe
Size
- A** Größe in Zoll
Size in inch
- B** Sitzrohrlänge
Seat tube length
- C** Oberrohrlänge
Top tube length
- D** Sitzwinkel
Seat angle
- E** Lenkwinkel
Head angle
- F** Steuerrohrlänge
Head tube length
- G** Kettenstrebenlänge
Chainstay length
- H** Radstand
Wheelbase
- I** Stack
Stack
- J** Reach
Reach
- K** Überstandshöhe
Standover height
- L** Tretlagerabsenkung
BB drop

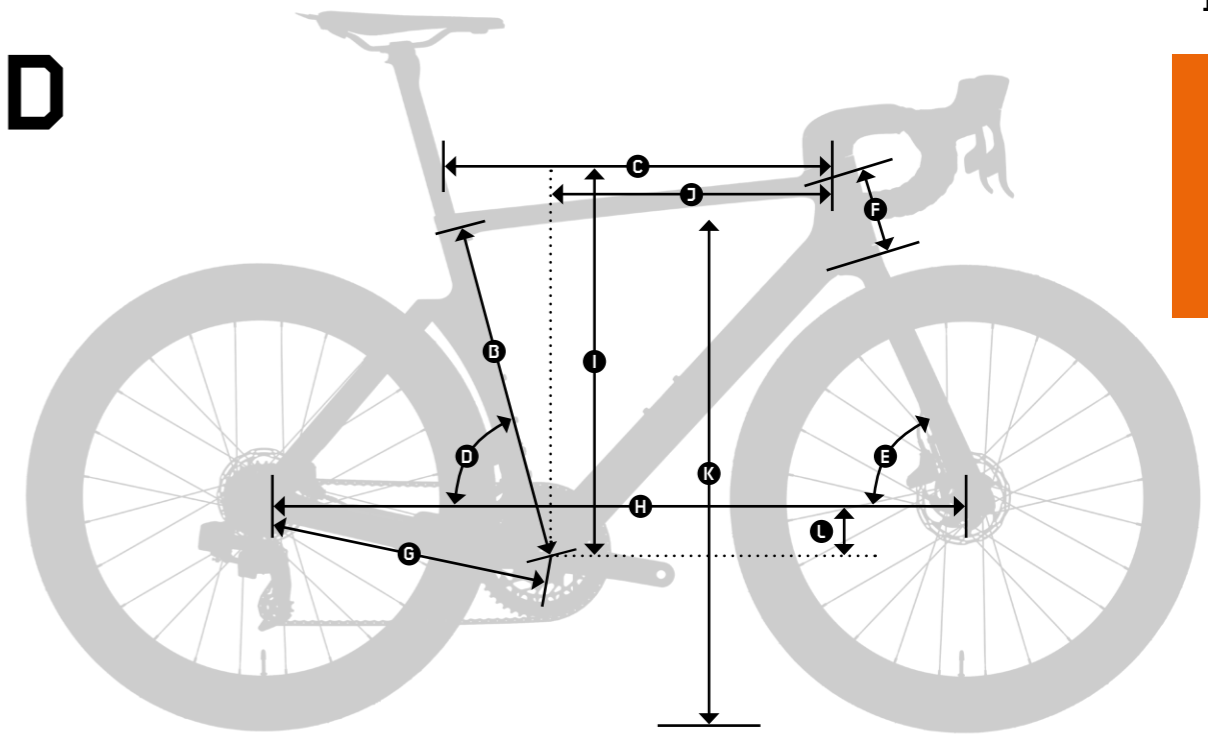

	A	A	A	B	C	D	E	F	G	H	I	J	K	L
REVELATOR LISSE	49	XS	19,5	440	517	76°	72°	100	410	982	526	386	733	72
	52	S	20,5	470	537	76°	72,5°	115	410	999	542	402	755	72
	55	M	21,5	500	557	75,5°	72,5°	130	410	1014	556	413	777	72
	57	L	22,5	520	570	75°	73°	140	410	1019	565	419	793	70
	59	XL	23,0	540	583	74,5°	73°	155	410	1028	576	423	810	68
REVELATOR ALTO	49	XS	19,5	490	510	75,5°	71,5°	130	410	975	533	372	742	72
	52	S	20,5	520	530	75,5°	72°	145	410	992	549	388	760	72
	55	M	21,5	550	550	75°	72°	160	410	1010	564	402	781	72
	57	L	22,5	570	563	74,5°	72,5°	170	410	1012	573	404	792	70
	59	XL	23,0	590	576	74°	72,5°	185	410	1021	585	408	809	68
REVELATOR 4000	49	XS	19,5	490	509	74,0/75,0°	72,0°	130	405	960	535	366	725	72
	52	S	20,5	520	529	74,0/75,0°	72,5°	145	405	976	551	381	747	72
	55	M	21,5	550	550	73,5/74,5°	72,5°	160	405	992	565	393	768	72
	57	L	22,5	570	561	72,5/73,5°	73,0°	175	405	989	580	389	785	70
	59	XL	23,0	590	572	72,5/73,5°	73,0°	200	405	1001	601	394	807	68
STRADA 1000	49	XS	19,5	490	509	75,0°	72,0°	130	410	965	534	366	734	72
	52	S	20,5	520	529	75,0°	72,5°	145	410	981	551	381	757	72
	55	M	21,5	550	550	74,5°	72,5°	160	410	997	565	393	779	72
	57	L	22,5	570	561	73,5°	73,0°	175	412	996	580	389	796	70
	59	XL	23,0	590	572	73,5°	73,0°	200	412	1008	601	394	819	68
X-STRADA MAN	49	XS	19,5	490	509	75,0°	71,0°	95	430	998	574	355	773	72
	52	S	20,5	520	529	75,0°	71,5°	100	430	1013	581	373	788	72
	55	M	21,5	550	550	74,5°	71,5°	115	430	1029	595	385	806	72
	57	L	22,5	570	560	74,0°	72,0°	130	430	1030	609	385	821	70
	59	XL	23,0	590	572	73,5°	72,0°	145	425	1038	622	388	831	68
X-STRADA LADY	49	XS	19,5	490	509	75,0°	71,0°	95	430	998	574	355	713	72
	52	S	20,5	520	529	75,0°	71,5°	100	430	1013	581	373	716	72
	55	M	21,5	550	550	74,5°	71,5°	115	430	1029	595	385	723	72
	57	L	22,5	570	560	74,0°	72,0°	130	430	1030	609	385	727	70
AXMAN TT FRAME	50	XS	20	506,3	490	78°	73°	50	400	953,5	384,7	495,2		
	52	S	20,5	525,8	510	78°	73°	70	400	975,3	400,7	514,4		
	54	M	21	545,4	530	78°	73°	90	400	997,1	416,6	533,5		
	56	L	22	564,9	550	78°	73°	110	400	1018,9	4			

TREKking OFFROAD

- A** Größe in cm
Size in cm
- A** Größe
Size
- A** Größe in Zoll
Size in inch
- B** Sitzrohrlänge
Seat tube length
- C** Oberrohrlänge
Top tube length
- D** Sitzwinkel
Seat angle
- E** Lenkwinkel
Head angle
- F** Steuerrohrlänge
Head tube length
- G** Kettenstrebenlänge
Chainstay length
- H** Radstand
Wheelbase
- K¹** Überstandshöhe Herren
Standover height
- K²** Überstandshöhe Damen
Standover height
- L** Tretlagerabsenkung
BB drop

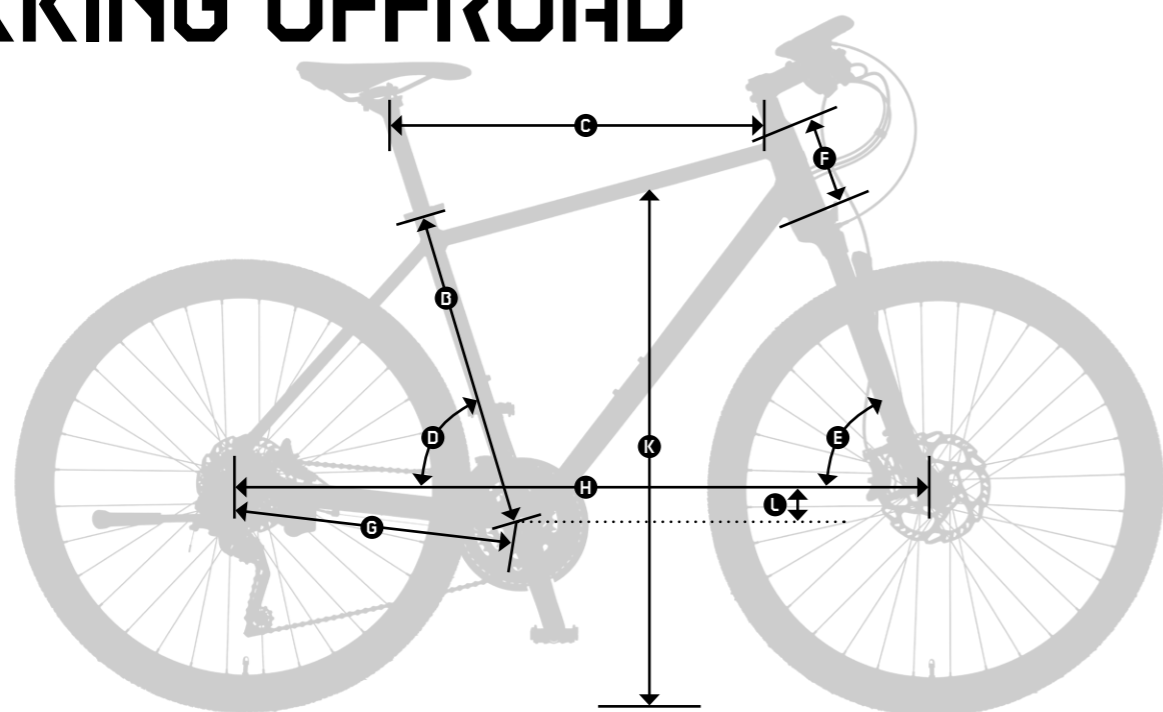

	A	A	A	B	C	D	E	F	G	H	K¹	K²	L
LIFE RACE / LIFE 1964 CROSS / LIFE ACTION / LIFE CROSS / LIFE ROAD / LIFE TRACK / LIFE TRACK STREET / LIFE ONE	43	XS	17	430	564	73.0°	70.5°	120	440	1052	-	678	55
	46	S	18	460	575	73.0°	70.5°	120	440	1063	786	675	55
	51	M	20	510	588	73.0°	70.5°	137	440	1077	815	677	55
	56	L	22	560	599	73.0°	70.5°	155	440	1089	847	678	55
	60	XL	23,5	600	616	73.0°	70.5°	174	440	1106	874	-	55

TREKking ONROAD

- A** Größe in cm
Size in cm
- A** Größe
Size
- A** Größe in Zoll
Size in inch
- B** Sitzrohrlänge
Seat tube length
- C** Oberrohrlänge
Top tube length
- D** Sitzwinkel
Seat angle
- E** Lenkwinkel
Head angle
- F** Steuerrohrlänge
Head tube length
- G** Kettenstrebenlänge
Chainstay length
- H** Radstand
Wheelbase
- K** Überstandshöhe
Standover height
- L** Tretlagerabsenkung
BB drop

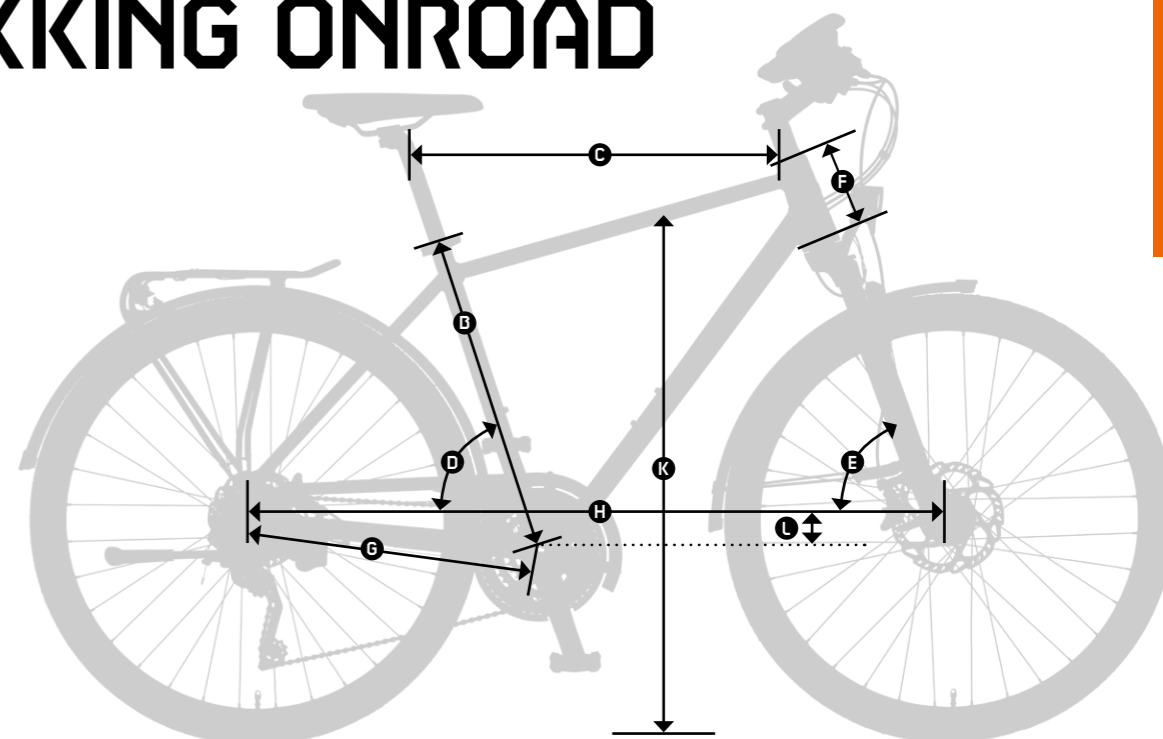

	A	A	A	B	C	D	E	F	G	H	K¹	K²	L
LIFE STYLE / LIFE TOUR / LIFE 8 BELT / LIFE 1964 / LIFE FORCE LIFE LITE / LIFE SPACE	46	S	18	460	575	73.0°	71.0°	120	452	1070	788	678	55
	51	M	20	510	588	73.0°	71.0°	137	452	1084	814	680	55
	56	L	22	560	600	73.0°	71.0°	155	452	1096	846	682	55
	60	XL	23,5	600	616	73.0°	71.0°	174	452	1113	874	-	55

LIFE 8 BELT / LIFE 1964 US	43	XS	17	430	579	71.5°	70.0°	150	474	1088	422		60
	46	S	18	460	590	71.5°	70.0°	160	474	1100	422		60
	51	M	20	510	600	71.5°	70.0°	174	474	1110	422		60
	56	L	22	560	618	71.5°	70.0°	190	474	1128	460		60

LIFE FORCE	43	XS	17	430	579	71.5°	70.0°	150	474	1088	469		60
LIFE LITE	46	S	18	460	590	71.5°	70.0°	160	474	1100	468		60
LIFE SPACE	51	M	20	510	600	71.5°	70.0°	174	474	1110	482		60
E	56	L	22	560	618	71.5°	70.0°	190	474	1128	479		60

LIFE TIME	43	XS	17	430	564	73.0°	70.5°	120	452	1064	-	706	55
LIFE JOY	46	S	18	460	575	73.0°	70.5°	120	452	1075	790	706	55
	51	M	20	510	588	73.0°	70.5°	137	452	1089	816	710	55
	56	L	22	560	600	73.0°	70.5°	155	452	1101	848	719	55
	60	XL	23,5	600	616	73.0°	70.5°	174	452	1119	875	-	55

LIFE TIME	43	S	18	460	583	72.0°	70.5°	160	452	1070	667		60
LIFE JOY	51	M	20	510	599	72.0°	71.0°	174	452	1081	674		60

LIFE TIME	43	XS	17	430	577	71.5°	70.0°	150	474	1088	469		60
LIFE JOY	46	S	18	460	595	71.5°	70.0°	160	474	1100	467		60
E	51	M	20	510	596	71.5°	70.0°	174	474	1110	482		60
	56	L	22	560	618	71.5°	70.0°	190	474	1128	480		60

LIFE RIDE	46	S	18	460	575	71.0°	73.0°	120	452	1069	780		55
	51	M	20	510	588	71.0°	73.0°	137	452	1084	820		55
	56	L	22	560	600	71.0°	73.0°	155	452	1096	851		55
	60	XL	23,5	600	616	71.0°	73.0°	174	452	1114	878		55

LIFE RIDE	43	XS	17	430	579	71.5°	70.0°	150	474	1088	469		60
E	46	S	18	460	590	71.5°	70.0°	160	474	1100	468		60
	51	M	20	510	600	71.5°	70.0°	174	474	1110	482		60

CITY

- A** Größe in cm
Size in cm
- A** Größe
Size
- A** Größe in Zoll
Size in inch
- B** Sitzrohrlänge
Seat tube length
- C** Oberrohrlänge
Top tube length
- D** Sitzwinkel
Seat angle
- E** Lenkwinkel
Head angle
- F** Steuerrohrlänge
Head tube length
- G** Kettenstrebene Länge
Chainstay length
- H** Radstand
Wheelbase
- K** Überstandshöhe Herren
Standover height
- L** Tretlagerabsenkung
BB drop

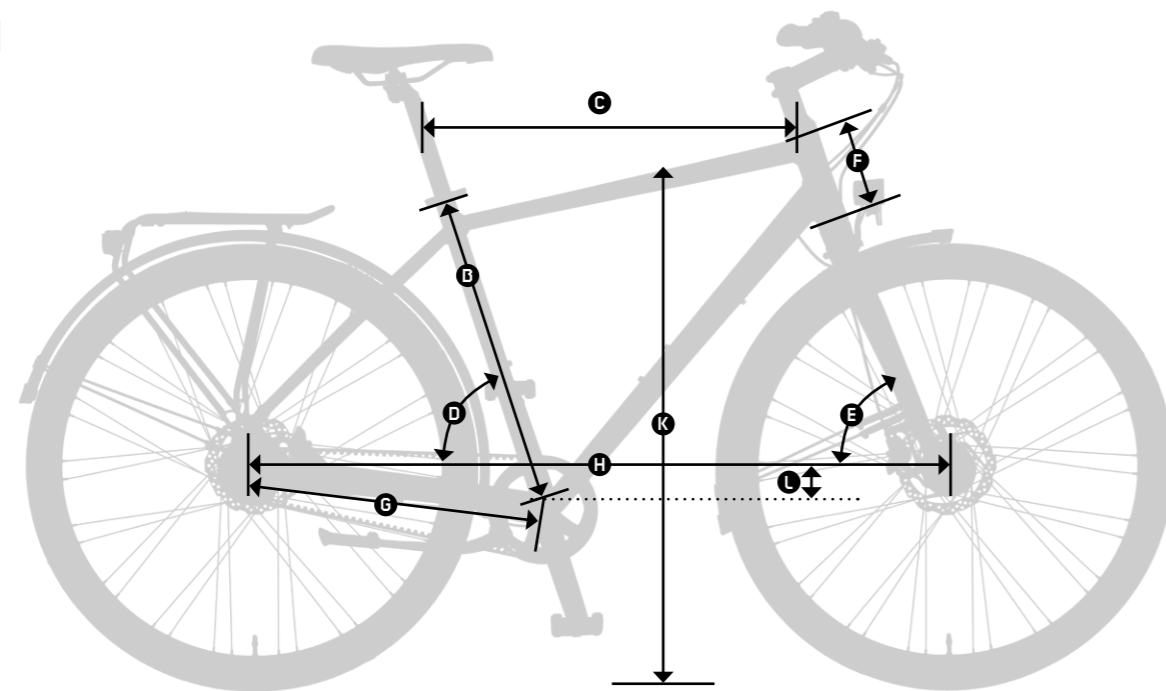

	A	A	A	B	C	D	E	F	G	H	K	L
KENT / CHESTER / OXFORD MAN	51	M	20	510	586	73,0°	71,5°	155	445	1073	796	60
	56	L	22	560	597	73,0°	71,5°	174	445	1096	827	60
	60	XL	23,5	600	612	73,0°	71,5°	190	445	1114	852	60
KENT / CHESTER / OXFORD LADY	46	S	18	460	574	73,0°	71,5°	137	445	1069	681	60
	51	M	20	510	586	73,0°	71,5°	155	445	1073	689	60
CITY LINE 28 WAVE	43	XS	17	430	582	71,5°	68,5°	160	482	1106	396	80
	46	S	18	460	594	71,5°	68,5°	174	482	1120	396	80
	51	M	20	510	612	71,5°	68,5°	190	482	1138	400	80
	56	L	22	540	625	71,5°	68,5°	190	482	1151	400	80
CITY LINE 26 WAVE	43	XS	17	430	575	72,6°	70,0°	150	458	1056	383	51
CITY FUN 28 WAVE	43	XS	17	430	600	72,6°	70,0°	160	482	1091	386	69
	46	S	18	460	612	72,6°	70,0°	174	482	1103	388	69
	51	M	20	510	620	72,6°	70,0°	190	482	1113	388	69
CITY FUN 26 WAVE	43	XS	17	430	576	72,6°	70,0°	160	458	1055	372	51

KIDS

- A** Größe in cm
Size in cm
- A** Größe
Size
- B** Sitzrohrlänge
Seat tube length
- C** Oberrohrlänge
Top tube length
- D** Sitzwinkel
Seat angle
- E** Lenkwinkel
Head angle
- F** Steuerrohrlänge
Head tube length
- G** Kettenstrebene Länge
Chainstay length
- H** Radstand
Wheelbase
- K** Überstandshöhe
Standover height
- L** Tretlagerabsenkung
BB drop

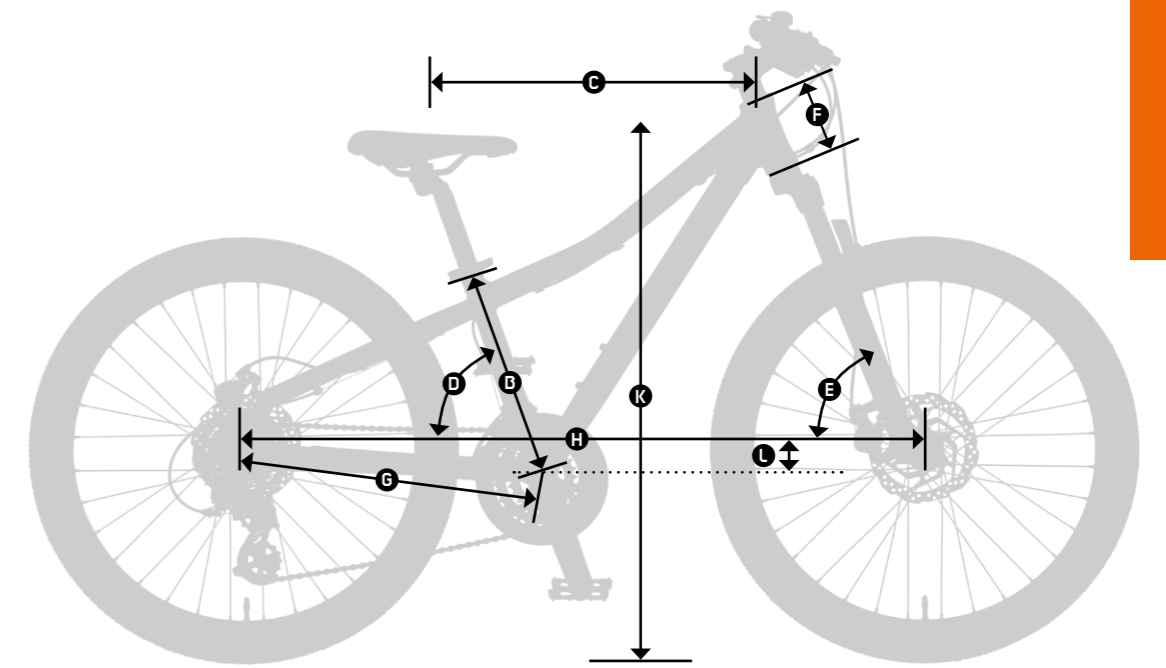

	A	A	B	C	D	E	F	G	H	K	L
COUNTRY STAR E	37	XS	370	555	71,5°	70,0°	137	435	1035	444	35
	43	S	430	574	71,5°	70,0°	160	435	1054	446	35
	51	L	510	587	71,5°	70,0°	160	435	1068	461	35
COUNTRY STAR LADY	37	XS	370	541	72,0°	125	125	430	1009	635	35
	42	S	420	561	72,0°	137	137	430	1029	648	35
	47	M	470	578	72,0°	155	155	430	1046	649	35
WILD SPEED DISC 26 WILD SPEED 26	34	152	340	522	73,0°	71,0°	120	430	1001	698	40
WILD SPEED DISC 24 WILD SPEED 24 WILD SPEED 24.9 WILD CROSS 24 WILD CROSS STREET 24 WILD BEE 24	31	128	310	484	72,5°	70,0°	100	420	954	604	50
WILD SPEED 20 WILD CROSS 20 WILD BEE 20	27	116	270	410	73,0°	71,0°	100	365	829	537	15
WILD ONE 24	31	128	310	484	72,5°	70,0°	100	420	954	633	50
WILD ONE 20	29	116	290	410	73,0°	71,0°	100	365	829	573	15
WILDCAT 24	35	128	350	522	73,0°	71,0°	120	400	979	412	25
WILDCAT 20	30,5	116	305	442	73,0°	71,0°	100	360	860	356	15

MADE IN AUSTRIA. MADE FOR YOU.





KTM-BIKES.AT

KTM FAHRRAD GMBH

Harlochnerstraße 13
5230 Mattighofen
Austria

KTM FAHRRAD DEUTSCHLAND GMBH

Adolf-Kolping-Straße 34
D-84359 Simbach am Inn
Germany